



UCSF

MAGAZINE

Fall 2012

BY OUR OWN DEVICES

Inventions that
are saving sight,
breath – and lives

BEATING BONE CANCER ODDS • ALUMNI LEADERS • DEMENTIA: CRACKING THE CODES



UCSF MAGAZINE
FALL 2012



FEATURES

12 Betting on Harry

A child with bone cancer beats incredible odds, thanks to the Pediatric Blood and Marrow Transplant team.

18 By Our Own Devices

Five inventors on five inventions that are changing the face of medicine.

26 Identity Theft

Neurologist William Seeley maps the path of dementia to link specific damage with behavioral changes – and wins a MacArthur “genius grant” along the way.

30 Putting Patients First

UCSF has a history of producing alumni who become health sciences leaders, from CEOs to chancellors. Meet four you won't forget.

DEPARTMENTS

- 2 What Matters
- 3 Dialogue
- 4 Inside UCSF
- 11 Faculty Accolades
- 24 Big Picture
- 36 Philanthropy
- 37 Alumni Hub
- 48 Double Take



No matter where you are in the world, UCSF is there.

From San Francisco to Swaziland, our clinicians are healing patients in major hospitals and local clinics. Our researchers are collaborating with colleagues across UCSF campuses, the biotech industry, and institutions as far away as Iceland to make discoveries that are changing the face of medicine. And our educators are training students from every corner of the globe, who are taking their expert skills back home to both treat patients and educate other health leaders.

Welcome to *UCSF Magazine*, where the stories of our worldwide impact will unfold. Each issue will explore what matters most to our clinicians, researchers, educators, students, alumni, and community members, as they work together to find the keys to understanding and treating disease.

In these pages, you'll learn that for Mort Cowan, head of our leading Pediatric Blood and Marrow Transplant Program at UCSF Benioff Children's Hospital, what matters is when patients like 4-year-old Harry Drake have a chance to play hard, laugh long, and live to blow out many birthday candles. For five extraordinary UCSF inventors, it's the synthesis of technology and medicine in devices that promise to prevent preterm births, blindness, and more. UCSF neurologist and MacArthur "genius grant" recipient Bill Seeley is focused on fighting the dementias that rob us of our sense of self, while four renowned UCSF graduates are revolutionizing human health care in their roles as the immediate past president of Doctors Without Borders – USA, a commanding general in the US Army, CEO of San Francisco General Hospital and Trauma Center, and dean of Xavier University of Louisiana College of Pharmacy.

Despite the breadth of our efforts, the UCSF community is inspired by a single goal: to set the world on course for a future free of disease. I am proud to share our progress along this journey, which ends with better health for people everywhere.

Susan Desmond-Hellmann, MD, MPH
Chancellor
Arthur and Toni Rembe Rock Distinguished Professor

UCSF MAGAZINE

FOR ALUMNI AND FRIENDS

FALL 2012 • VOL. 1 NO. 1

EDITOR

Stephanie Bruzzese

EXECUTIVE EDITOR

Anne Kavanagh

SENIOR EDITORIAL ADVISOR

David Arrington

ASSOCIATE EDITORS AND SENIOR WRITERS

Claire Conway

Kate Volkman

SENIOR DESIGNER

Audrey Feely

SENIOR DESIGN ADVISOR

Nada Salam Hansen

WEB DIRECTOR

Michele Foley

EDITORIAL ADVISORY TEAM

Lisa Cisneros, David Hand, Andrew Kaufteil,
Susan Levings, Jennifer O'Brien, Sarah Paris,
Amy Pyle, Erika Smith, Megan Smith

CONTRIBUTING WRITERS

Jason Bardi, Stephanie Bruzzese,
Elizabeth Fernandez, David Hand,
Anne Kavanagh, Jeffrey Norris, Jennifer
O'Brien, Peterson Skolnick & Dodge,
Rob Waters, Patricia Yollin

DESIGN CONSULTANTS

Jacqueline Jones Design, Price Watkins Media

PRINTING

Lane Press

**VICE CHANCELLOR, STRATEGIC
COMMUNICATIONS AND UNIVERSITY RELATIONS**
Barbara French

**VICE CHANCELLOR, UNIVERSITY DEVELOPMENT
AND ALUMNI RELATIONS**
John Ford

UCSF Magazine is published twice a year by the UCSF
Office of University Development and Alumni Relations.

© 2012 by The Regents of the University of California.

CONTACT US

UCSF Magazine, UCSF Box 0248

San Francisco, CA 94143-0248

415/476-3480

ucsfmag@support.ucsf.edu

For change of address, email:

magaddress@support.ucsf.edu

WEB

support.ucsf.edu/magazine

Printed on recycled paper

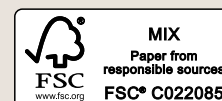

di·a·logue, n. [dahy-uh-lawg, -log]

Conversation, discussion, discourse, interchange, TALK.

Pick any day to visit UCSF, and dozens of discussions about the future of science and medicine will be taking place within earshot alone. **We welcome you to *UCSF Magazine*** – a semiannual forum for those conversations, which often start with an idea that ultimately impacts patients around the world.

We invite you to share your perspectives on this dialogue by sending us your letters for inclusion here. Let us know your take on our health care discourse.

Write Us

UCSF Magazine

UCSF Box 0248

San Francisco, CA 94143-0248

ucsfmag@support.ucsf.edu

Letters selected for publication may be edited for length and clarity.

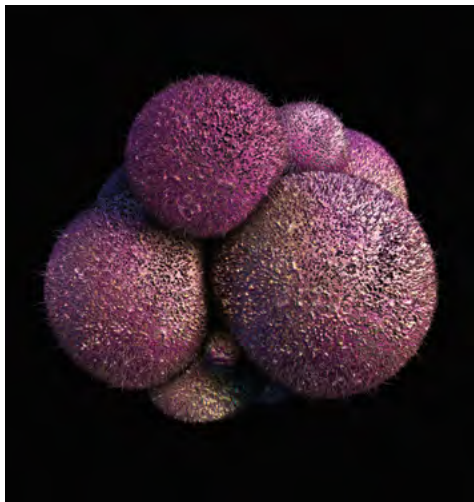

STEM CELL STARLET

There's a new star in the field of regenerative medicine: the tooth. Ophir Klein, MD, PhD, is exploring how stem cells generate new teeth – and how development goes awry in craniofacial disorders. “Continuously growing teeth have evolved a number of times in different mammals – elephants, rabbits, lemurs – so we can assume that this is a relatively easy evolutionary switch to flip,” says Klein, director the UCSF Program in Craniofacial and Mesenchymal Biology. And in a surprising discovery, he found some of the same molecules that spur stem cells in the teeth to divide

and renew themselves also act in the intestines. Cells live and die quickly in the intestines, with the population on the gut surface turning over approximately every five days. His discovery has research implications for a number of intestinal diseases, such as inflammatory bowel disease. Klein, a member of the Eli and Edythe Broad Center of Regeneration Medicine and Stem Cell Research, was recently awarded a coveted National Institutes of Health Director's New Innovator Award – making the tooth's prospects for stardom even brighter.

RUNNING FROM PROSTATE CANCER

The scaffold supporting prostate cancer is rapidly coming down, thanks to advances by both researchers and clinicians at the UCSF Helen Diller Family Comprehensive Cancer Center.

On the research front, UCSF faculty showed that brisk walking or vigorous exercise – such as jogging for three or more hours a week – is linked to a lowered risk of prostate cancer progression and death after diagnosis. The potential explanation: 184 genes whose expression in the prostate gland is linked to vigorous exercise.

“Vigorous physical activity may provide clinical benefits for men diagnosed with earlier stage prostate cancer,” says senior investigator June Chan, ScD, who partnered with the Harvard School of Public Health and Duke University Medical Center in the discovery. “The finding suggests some interesting leads on mechanisms by which physical activity may protect against prostate cancer progression.”

On the clinical side, a UCSF-led trial of a new medication, abiraterone acetate (marketed as Zytiga), revealed the drug's

success in slowing the spread of metastatic prostate cancer. The drug proved so effective that the trial was “unblinded” midway through, allowing patients receiving the placebo to instead take the drug.

The study is the first randomized clinical trial to document expanded benefits among a particular group of prostate cancer patients in whom the disease had spread. The medication also delayed the development of pain and deterioration of the patients' overall condition.

“This drug extended lives and gave patients more time when they weren't experiencing significant pain from the disease,” says the principal investigator of the international trial, Charles J. Ryan, MD.

“This is an interim analysis; the final analysis should be available in a year or so,” he says. “But it appears that this finding may lay a foundation for the use of this drug at an earlier stage of prostate cancer – and it may benefit a much wider population of patients as a result.”



PHOTOS: FROM TOP: BJORN MEYER, JOSHUA HODGE

HEALTH HISTORIES GO DIGITAL



UCSF Medical Center's new electronic health records system, among the most comprehensive systems in the country, captures a patient's entire UCSF medical history in a single e-file – relegating paper files to the past.

Keeping medical records straight can push a sick person over the edge, but a bold new initiative at UCSF Medical Center is helping patients stay on the right side of wellness.

In June 2012, the Medical Center completed its rollout of a new electronic health records system called APeX – short for Advancing Patient-Centered Excellence. Among the most comprehensive systems in the country, APeX creates a single electronic health record for every UCSF outpatient and inpatient.

Each record reads like a play-by-play of the patient's whole medical history at UCSF, from inpatient clinical documentation and order entry by clinicians; to the emergency department, the intensive care units, the operating rooms, and anesthesia; to hospital registration, admissions, scheduling, and professional billing. And because the records can be accessed online, UCSF caregivers and patients themselves are no longer forced to shuttle paper files back and forth – an old-fashioned approach with more potential for error.

“The system allows providers to rapidly gather data, analyze it, and respond more quickly. You immediately have improvements in quality of care and safety,” says Michael Blum, MD, chief medical information officer at UCSF Medical Center, who led the provider aspects of the implementation.

Blum cites the example of a medication order to demonstrate the system's benefits. “When a provider enters a medication order, it's completely legible, and for children the dose has been calculated based on their specific weight,” he says. “The order instantly zips down to the pharmacy, where it's scrutinized for safety, and then gets dispensed to the patient much more rapidly. As a final check, the nurses use bar-code scanners when administering the medications – ensuring that it's the right dose of the right medication, going to the right patient at the right time.”

“Someday people may be able to take a drug that makes them naturally more resilient to disease and able to live longer”

Aging expert and UCSF scientist Cynthia Kenyon, PhD, quoted in the *Philadelphia Inquirer*.



PRECISION MEDICINE: BIOMEDICAL KNOWLEDGE NETWORK

Imagine a world where the vast wealth of data related to human health – molecular discoveries, environmental factors, genetic histories, electronic health records – was brought together in a global network with the power to create an individualized treatment plan for any patient, anywhere.

That world is here in a new Biomedical Knowledge Network recently announced by a National Academy of Sciences (NAS) committee co-chaired by UCSF Chancellor Susan Desmond-Hellmann, MD, MPH.

Centered on an interactive data repository constantly refreshed with the latest information, the Knowledge Network would link layers of generalized data – environmental and microbial exposures, disease signs and symptoms, epigenetics, clinical trial outcomes, and much more – with individual patient data.

Clinicians could use the network to make more informed diagnoses and treatment decisions, improving care while reducing its costs. Basic scientists could use it to mine and manipulate patient data in order to uncover the mechanisms behind disease.

Keith Yamamoto, PhD, vice chancellor for research at UCSF, who served on the NAS committee, considers the proposal “the most important NAS Framework Analysis since that advisory body recommended – in a 1988 report chaired by UCSF Professor Bruce Alberts, PhD – that the United States go forward with the Human Genome Project.”

PARTNERING WITH PUBLIC SCHOOLS

Yesmina Zavala defies gravity – just ask a social scientist. Because her parents didn't attend college, Zavala had only a 55 percent likelihood of attending herself. She rose above those odds with a full scholarship to UC Berkeley.

She credits UCSF's Science & Health Education Partnership (SEP) for her success. Now in its 25th year, the program supports science teachers in the public schools and redefines the chances of academic success for disadvantaged students in the San Francisco Unified School District (SFUSD). Zavala was one of 20 students who are tapped each year by their high school teachers to be part of SEP's High School Internship Program (HIP), which places students in part-time UCSF laboratory positions the summer after their junior year. "The teachers look for students who are very talented and have potential, but they haven't seen that in themselves yet," says Rebecca Smith, co-director of SEP. "These are kids who would never even think to consider a science internship. They are trying to figure out if college is something they can do or not."

Zavala worked in the lab of Obstetrics and Gynecology Professor Synthia Mellon, PhD, trying to identify a gene possibly linked to cervical cancer. "At first I was overwhelmed, wondering how I would ever learn how to use all the gadgets and equipment," recalls Zavala, now 26 years old and working at Kaiser Permanente as a workplace safety project manager. "With help, I got the hang of it. That's when I knew I could do absolutely anything if I put my mind to it."

Two hundred students have gone through the internship program, each with his or her own transformative story. Critical to those stories are the workshops that educate the students on how to select a college, apply for financial aid, and write a personal essay. More than 90 percent of HIP alumni go on to college. "What's really striking is that 80 percent earn bachelor's degrees in science – that exceeds statistics of any demographic in the US," says Smith. Nearly 90 percent acquire degrees beyond a bachelor's degree.

"Honestly, I don't know where I would be now without SEP," says Zavala. "So many of my high school peers, given their life experiences, were lost then and still are."

The internship is only one of SEP's programs. SEP builds partnerships between UCSF scientists and K-12 teachers in the SFUSD. Partnership teams co-teach science or health lessons in the most engaging, experiential way possible. Last year 143 such partnerships were created, serving more than 4,000 K-12 students. For most students, it is their first exposure to a real scientist. "We try to break down stereotypes about who scientists are," says co-director



An example of the Science & Health Education Partnership at work: volunteer scientist Charlie Morgan, PhD, puts science in a relatable context for a student from San Francisco's Mission High School.

Katherine Nielsen. SEP's research (and that of other groups) shows that kids assume scientists are white men, mostly with crazy hair. "We have a lot of evidence that after a SEP partnership, their perceptions change from stereotype to the point that they can see themselves in the role."

Scientists help teachers devise experiments so that students can experience the real process of science. Likewise, teachers work with scientists to frame their information for a young audience. The teacher/scientist pairs meet in the SEP offices and avail themselves of all the microscopes, human organs, and organ models that can be borrowed from SEP's Daly Ralston Resource Center. Last year a scientist brought two lungs into a classroom – one healthy and the other of a smoker. "The teacher told us that one of the

students convinced her parents to stop smoking after seeing the two lungs," says Nielsen.

San Francisco teachers also participate in SEP's week-long summer institutes, which integrate adult-level science content with teaching strategies. "The goal is to teach science to teachers in a way that they've never been taught before," says Smith. "So they have this 'a-ha!' When science is taught like this, it is fun and interesting. They can implement those same

strategies in their own classroom."

The Bay Area Science Festival is SEP's most high-profile program. Inaugurated last year, the 10-day event was attended by more than 70,000 people. The festival is a series of 100 interactive scientific and technological events held in collaboration with Bay Area academic, scientific, and corporate institutions. Smith, shocked by the number of attendees – 20,000 – at the culminating event at AT&T Park, tried to manage the crowds. "I attempted to redirect some kids to another area by saying, 'Hey, you can touch a human brain if you go over there,'" recalls Smith. "One said, 'Nah, I have already touched three brains today.' Now that's a good day in science."

ON THE NOBEL NIGHTSTAND: WHAT UCSF'S NOBEL LAUREATES ARE READING

J. Michael Bishop, MD

Forgotten Kingdom By Peter Goullart

"It's a memoir by a refugee from the Russian Revolution who wound up living and working in Yunnan, a remote province in the southwestern part of China. I am reading it in part because I just visited Yunnan myself and found the book in an airport store there."



Elizabeth Blackburn, PhD

Proust and the Squid: The Story and Science of the Reading Brain By Maryanne Wolf

"It is opening up new avenues of thought for me."

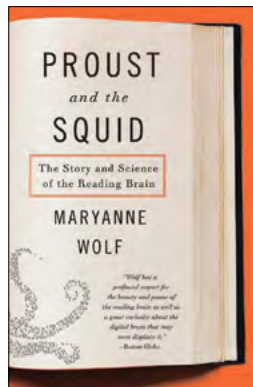

Stanley Prusiner, MD

Steve Jobs By Walter Isaacson

"The book is fascinating and well written, and resonates with me because I was living in the Bay Area during the rise of Apple. I yearned for Apple to survive because I don't know how to use a PC."

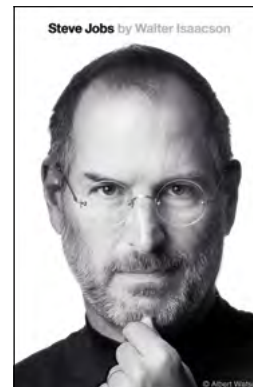

GAME ON AGAINST PARKINSON'S

Move over, Wii Fit: the UCSF departments of physiological nursing and physical therapy and rehabilitation science have created an exercise-based video game that has markedly improved coordination in people with Parkinson's disease.

In partnership with serious game developer Red Hill Studios, the team – led by Glenna Dowling, RN, PhD, and Marsha Melnick, PT, PhD – produced nine “clinically inspired” games designed to improve gait and balance in patients with Parkinson's, a chronic, progressive neuromuscular disease characterized by shaking, slowness of movement, and limb and trunk rigidity.

The games focus on specific body movements and gestures that are beneficial for staving off the physical declines of Parkinson's, with players winning points by moving their bodies in specific and increasingly difficult ways.

In a 12-week trial of game players with moderate levels of Parkinson's, 65 percent demonstrated longer stride length, 55 percent had increased gait velocity, and 55 percent reported improved balance confidence.

The National Institute of Neurological Disorders and Stroke funded the study with two Small Business Innovative Research grants totaling \$1.1 million, the first federal funding granted in the burgeoning field of low-cost computerized physical therapy games.

Like their trial participants, the UCSF team is not sitting still. A longer trial with more subjects is in the works.



“We think we are at the beginning of the end of the AIDS epidemic.”

AIDS expert and UCSF physician Diane Havlir, MD, who co-chaired AIDS 2012, the XIX International AIDS Conference held in July in Washington, DC, quoted on **NBC News.com**.

“It’s like trying to think about a body without a heart.”

UCSF biochemist Wallace Marshall, PhD, on his finding that flatworms lack a key cellular structure called a centrosome, which scientists have long considered essential for cell division, quoted in the *San Francisco Chronicle*.



TUMOR VS. TUMOR

Neurosurgeon Andrew Parsa, MD, PhD, is fighting fire with fire. His new brain cancer vaccine, crafted from patients’ own tumors, is extending lives by several months or longer in phase 2 clinical trials. The patients studied suffer from recurrent glioblastoma multiforme, which kills thousands of Americans every year.

The trial found the vaccine extended survival for more than 40 patients by several months when compared to 80 other patients who were treated at the same hospitals and received standard therapy – 47 weeks compared to 32 weeks. Several of the patients who received the cancer vaccine have survived for more than a year.

“These results are provocative,” says Parsa, a principal investigator with the UCSF Brain Tumor Research Center. “They suggest that doctors may be able to extend survival even longer by combining the vaccine with other drugs that enhance this immune response.”

The next step, he says, will be a more extensive, randomized clinical trial to look at the effectiveness of the vaccine combined with the drug Avastin, a standard therapy for this type of cancer, compared to the effectiveness of Avastin alone. Those trials, to be run by the National Cancer Institute, will begin enrolling patients later this year.

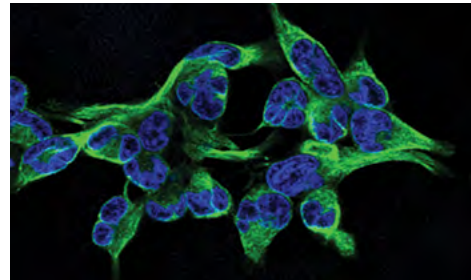

Glioblastoma is the most aggressive brain tumor and may be a key to the development of a brain cancer vaccine.

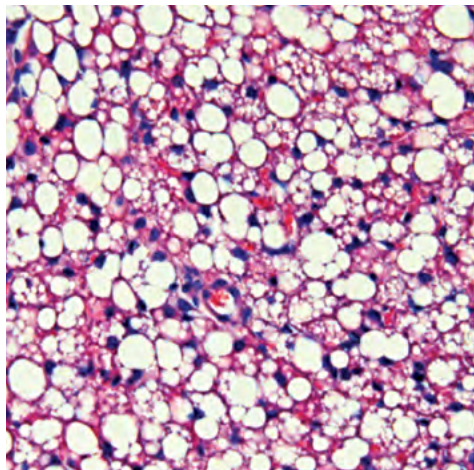

The brown in brown fat cells comes from the many cellular power plants, or mitochondria, burning fuel within them. The more brown fat people have, the less likely they are to be obese.

THE GOOD FAT

UCSF researchers may well have uncovered a new weapon against obesity: fat. Shingo Kajimura, PhD, an investigator in the UCSF Diabetes Center, has found that a protein, PRDM16, converts ordinary, calorie-hording fat cells to calorie-burning brown fat cells in mice. If such a conversion were possible in humans, the body would burn calories more quickly and efficiently – creating a whole new approach to weight loss in patients suffering from obesity and/or diabetes.

Like shivering, brown fat is one of the tools our bodies use to ward off cold. Brown fat burns fatty acids, which heats the blood and, by extension, the body. Scientists recently discovered that the more brown fat people have, the less ordinary fat they have. Likewise, the more brown fat people have, the less likely they are to be overweight.

While studies have shown that drugs called PPAR-gamma ligands increase brown fat in diabetes patients, researchers have been puzzled about the reason why – until now. In their mouse models, Kajimura and his colleagues have revealed that PPAR-gamma stabilizes the PRDM16 protein, leading to its accumulation in cells. The accumulation appears to throw a genetic switch, converting the white fat cells to brown. Whether this process can be replicated safely in human patients is the very promising question Kajimura is working to answer.

LIVING GREEN AT UCSF: BY THE NUMBERS

14 Years UCSF has hosted an annual green awareness event

598,271 Dollars saved in FY11-12 by collecting single-use devices from UCSF operating rooms and cardiac catheterization laboratories for reprocessing by a third-party vendor, and later repurchased at a discount

1,097 2012 LivingGreen Fair and Bike to Work Day participants

2,174 Pounds of books collected by UCSF and San Francisco General Hospital and Trauma Center libraries for a book drive in 2012

7 LEED (Leadership in Energy and Environmental Design) buildings certified by the US Green Building Council

100 Percent of all new campus construction to meet at least the LEED Silver standard, and the percent of all new building projects that achieve at least two points in the water efficiency category

2014 Year by which UCSF will have reduced energy consumption by 10 percent or more from the year 2000 base level

189 Tons of scrap metal recycled by craft workers (plumbers, building maintenance workers) in FY11-12

52 Weeks per year UCSF offers farmers markets on its campuses

100 Percent of local (Sonoma) organic yogurts served to patients and visitors at UCSF Medical Center, and the percent of organic baby food and organic strawberries served to patients at UCSF Benioff Children's Hospital

73 Percent of local and/or organic sustainable food purchases at UCSF Medical Center in June 2012

63 Percent of solid waste the campus diverted from landfill in FY11-12

2,057 Tons of food composted in 2011

“Ultimately this is a public health crisis. And when it’s a public health crisis, you have to do big things and you have to do them across the board.”

UCSF endocrinologist Robert Lustig, MD, explaining on *60 Minutes* why he believes sugar should be controlled like tobacco and alcohol.



CLENCHED TEETH

Psychologist Linda Centore, ANP, PhD, chairs the Division of Behavioral Sciences and Community Dental Education in the School of Dentistry. She has spent 26 years working with individuals with dental fear.

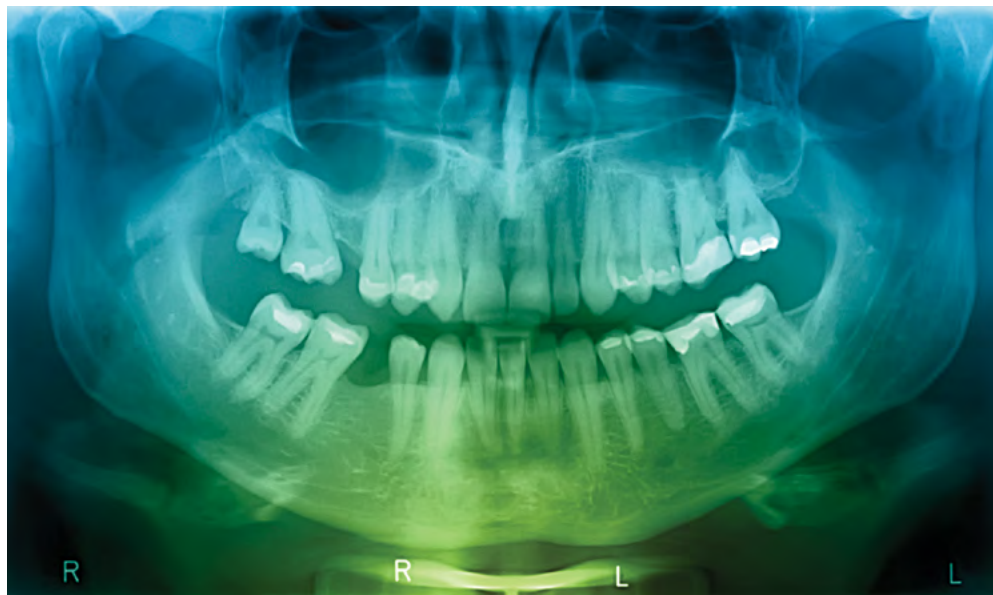

Even the awkward pinch of X-ray films can give rise to anxiety in patients who are prone to dental fear.

Who is most likely to fear dentistry?

Centore: It is often someone who has had a negative past experience – a painful dental appointment as a child or a toothache as a young adult. Or they may have a fear of needles, which is true of 15 to 20 percent of adults.

Is there something inherently scary about dentistry?

Centore: You are lying back in a chair with your mouth – a very private place – wide open with instruments in it. Add to that a mixture of sensations and sounds – water, suction, and vibration – and being unable to speak. All with your dentist towering over you. This is inherently scary.

How do you figure out if a patient is fearful?

Centore: We take a dental history that accounts for patient experience and comfort. It covers questions such as, “Do you have trouble sleeping

the night before dental treatment?” Or, “On a scale of one (low) to 10 (high), how anxious, worried, or fearful are you of having dental treatment?” Then we ask specific questions about what part of the appointment leads to dental fear or anxiety. It might be that every step from the elevator to the dental chair is anxiety-provoking. Or it might be just one thing – the injection or the sound and vibration of the drill.

Sounds like a lot to process...is it?

Centore: Dentistry is a microsurgical specialty. Dentists have to do intricate treatment with magnifying lenses and small margins of error. And perception in the mouth is exquisite – people can sense the slightest nuance of change. Think about when a crown feels too high. Like a sand particle in the eye, it is very bothersome. A root canal, for instance, is a three-dimensional microsurgical procedure, not unlike hand surgery. Only the dental surgeon is working on a patient who is awake and within 18 inches of the face. Dentists

have to have both the technical skills to do the complex procedures and the charm and warmth to get a person through all the uncomfortable sensations associated with shots, rubber dams, drilling, carving, and suction.

What are the best ways patients can manage dental fear themselves?

Centore: Breathe slowly during injections. The slower you breathe, the less pain you feel. It activates the relaxation part of the autonomic nervous system. Bring your favorite music and headphones so the sounds you hear are the ones you want to hear. Give yourself a reward after the appointment, like seeing a friend or going to a movie. Avoid excessive amounts of stimulants, like caffeine or Sudafed, so that you can relax in the chair. And finally, be open and honest about your dental fear and what helps you feel comfortable.

How do you help fearful patients who can't help themselves?

Centore: After finding out the triggers, I create a comfort recipe. This might include slowed abdominal breathing, progressive relaxation, visual imagery, or light trance hypnosis. An oral medication, like Valium or Ativan, or a gas, like nitrous oxide, reduces anxiety and fear. The person is awake but just more relaxed. Getting to know a person and what would work best for her or him is the goal. Dentistry should be so comfortable that a person is relaxed enough to take a nap during the treatment!

FACULTY ACCOLADES

Lisa Bero, PhD, was named director of the World Health Organization (WHO) Collaborating Center for Pharmaceutical Research and Science Policy. The new center will be based in the School of Pharmacy's Department of Clinical Pharmacy, where Bero is a professor and vice chair for research. The center seeks to combine high-quality academic research with WHO's political clout to remove roadblocks that prevent people in lower-income countries from receiving the most crucial and effective medications.

Jill Howie-Esquivel, RN, NP, PhD, an assistant professor in the School of Nursing's Department of Physiological Nursing, won a competitive grant from the Robert Wood Johnson Foundation to develop an intervention to help Latinos prevent and manage heart failure. Howie-Esquivel, a UCSF alumna, was one of just 12 nurse educators from around the country to receive the three-year, \$350,000 Nurse Faculty Scholar award in 2011. It is given to junior faculty who show outstanding promise as future leaders in academic nursing.

Michael Fischbach, PhD, who studies drug-like molecules produced by human gut bacteria, was awarded one of the 16 2011 Packard Fellowships in Science and Engineering. The prestigious fellowship, which supports "highly creative professors early in their careers," provides an unrestricted research grant of \$875,000 over five years. Fischbach is an assistant professor in the Department of Bioengineering and Therapeutic Sciences, a joint department of the Schools of Pharmacy and Medicine.

John S. Greenspan, BSC, BDS, PhD, FRCPath, received the 2012 American Dental Association Gold Medal Award for Excellence in Dental Research, one of the top honors in the field of American dentistry. He was recognized for his groundbreaking research in the oral aspects of AIDS and the role of viruses in oral lesions. Greenspan is a professor in the Department of Orofacial Sciences, and the associate dean for Global Oral Health in the School of Dentistry.

Louis Ptacek, MD, was elected a member of the National Academy of Sciences, one of the highest honors bestowed on scientists and engineers in the United States, for his research on the biology and genetics of several human diseases and disorders – from epilepsy and migraine to sleep disorders and jet lag. Ptacek is a professor in the School of Medicine's Department of Neurology and a Howard Hughes Medical Institute investigator.

Karin Vargervik, DDS, a professor in the School of Dentistry's Department of Orofacial Sciences, received the Honors of the Association award from the American Cleft Palate and Craniofacial

Association – the foremost expression of respect and gratitude bestowed by the organization.

School of Nursing Dean **David Vlahov, RN, PhD**, and three other UCSF faculty members were elected to the Institute of Medicine, one of the highest honors in the fields of health and medicine, in October 2011. The other new UCSF members are School of Medicine professors **Claire Brindis, DrPH, MPH**, Departments of Pediatrics and Obstetrics, Gynecology and Reproductive Sciences; **Yuet Wai Kan, MB, DSc**, Departments of Medicine and Laboratory Medicine; and **Mark von Zastrow, MD, PhD**, Department of Psychiatry.

To read more about faculty research, visit profiles.ucsf.edu.

PROFESSORS WIN 2012 NOBEL PRIZE, LASKER AWARD

As this magazine went to press, the 2012 Nobel Prize in Physiology or Medicine was awarded to **Shinya Yamanaka, MD, PhD**, a senior investigator at the Gladstone Institutes and a professor in the School of Medicine's Department of Anatomy. He shares the prize with John B. Gurdon, Kt, DPhil DSc, FRS, of the Gurdon Institute in Cambridge, England.

This award acknowledges the scientists' work in cellular reprogramming. Yamanaka made the discovery that changing the expression of a few carefully selected genes can convert adult cells, such as those of the skin, into induced pluripotent stem cells, or iPS cells, capable of developing into any cell in the human body. His finding has altered the fields of cell biology and stem cell research, opening promising new prospects for the future of both personalized and regenerative medicine. Look for more coverage of Yamanaka's work in the spring edition of *UCSF Magazine*.

Ronald Vale, PhD, was one of three scientists awarded the 2012 Albert Lasker Basic Medical Research Award, among the most respected science prizes in the world. The researchers' work, which began more than three decades ago, has helped illuminate several critical aspects of life, including how the heart beats and how cells transport material around internally. The other two scientists were James Spudich, PhD, of Stanford University, and Michael Sheetz, PhD, of Columbia University. Vale is professor and vice chair of the Department of Cellular and Molecular Pharmacology in the School of Medicine and a Howard Hughes Medical Institute investigator.



Betting on Harry

By Kate Volkman

As the parent of a bone marrow transplant patient, there are a few milestones that you long for your child to reach. Katie and Julian Drake were told that if their son Harry made it to six weeks post-transplant, he was in good shape. If he made it to six months, he was in really good shape. And if he made it to a year, well, he was golden.

Four years later, the Pediatric Blood and Marrow Transplant team at UCSF Benioff Children's Hospital calls Harry a miracle.

The team is widely known for making miracles happen: their efforts have helped Benioff Children's Hospital rank among the top pediatric centers in the country for higher-than-expected patient survival following bone marrow transplants. In a recent review of 156 transplant centers nationwide, the Center for International Blood and Marrow Transplant Research estimated that the median chance for survival at one year post-transplant is 63.4 percent – compared to 87.6 percent at UCSF.



When the Good Life Goes Bad

On Nov. 27, 2007, Harry Drake came into the world. The much-anticipated second child of Katie and Julian, Harry was so easygoing that his somewhat reserved English parents went so far as to call him an angel.

In June 2008, the Drakes felt they had finally set a foot on the ladder to the good life. They were the owners of a new home and car, and had jobs they enjoyed. Their elder son, Jack, was an energetic 3-year-old. And at 6 months, Harry was starting to sleep through the night. The Drakes celebrated one Sunday with an outing to a nearby lake, stopping at their favorite ice cream shop on the way home.

But as Katie uploaded photos from the day to her computer that night, one picture in particular caught her eye: a shot of Harry with an odd bump on his head, about the size of a quarter and shaped like a horseshoe.

Bumps and bruises on Harry weren't new. The day he was born, they noticed a bruise on his face and another on his forehead, but his doctors thought they were birthmarks. Over the next few months, he developed other bruises. A dermatologist diagnosed him with a harmless skin disorder that would likely clear up by the time he reached his first birthday.

The picture from that Sunday told an undeniably different story, however. Katie emailed it to her new pediatrician, who asked her to bring Harry in the next day. After a week of appointments and tests, on Friday, June 13, the Drakes received his official diagnosis: acute myelogenous leukemia, or AML.

"Knowing your child has cancer is bad enough," says Katie. "Then finding out it's a rare type, then an aggressive type. Then learning it has spread into his cerebrospinal fluid, he has a 50/50 chance of survival, and the treatment you're about to put him through is very toxic. It was devastating news."

Harry started chemotherapy that day.

When the pediatrician told Katie to pack her bag for the hospital, she brought enough for one night. "I had to laugh because I packed just a toothbrush and a pair of underwear for me, but for Harry, I packed all these baby clothes. The irony was that he spent the next six months in mostly a hospital gown."

After five weeks at the hospital where the Drake boys were born, California Pacific Medical Center (CPMC), Harry finished what became his first round of chemotherapy. Two days later, the Drakes learned that although the cancer in Harry's blood was in remission, cancer cells remained in his spinal fluid. He was classified as a relapse, and his



June 8, 2008: Family outing. Five days later, Harry would be diagnosed with leukemia.



August 2008: Receiving chemotherapy. Surrounded with baby toys, Harry preferred to fiddle with medical equipment.



September 2008: At their weekly meeting, Mort Cowan and the pediatric BMT team discussed Harry's case.

chances of survival decreased to 20 percent. The only way he might make it was by receiving a bone marrow transplant – and there was no better place than UCSF.

Factors for Success

A bone marrow transplant can be a lifesaving treatment for children with cancer, like Harry, as well as diseases of the immune system, aplastic anemia, inherited diseases of the bone marrow, and some metabolic diseases.

Bone marrow is the spongy substance found in the center of bones. It manufactures bone marrow stem cells, which produce red blood cells, platelets, and white blood cells. Red blood cells carry oxygen to tissues in the body, platelets help blood to clot, and white blood cells fight infections.

Unlike solid organs, which can be transplanted in their entirety, it's not possible to extract all of the marrow from every bone in a patient's body. Instead, the existing marrow is killed with extremely high doses of chemotherapy, often followed by radiation. It's then replaced with healthy marrow, injected into the bloodstream through an intravenous tube. Within two to three weeks, the new marrow begins to grow inside the recipient's bones.

The Pediatric Blood and Marrow Transplant Program at UCSF was established in 1982 by immunologist Mort Cowan, MD, now the chief of the Allergy, Immunology, and Blood and Marrow Transplant Division. Since then, nearly 1,000 bone marrow transplants have been performed at UCSF, at an average of 50 to 60 per year.

Cowan attributes the program's 87.6 percent one-year survival rate to three main factors: a multidisciplinary team, dedicated to bone marrow transplant; the team's ability to be highly selective with donor matching; and their constant influx of research and clinical innovations.

Multidisciplinary, Dedicated Team

Cowan has built a team of more than 20, including physicians – a variety of hematologists, oncologists, and immunologists – nurses, nurse coordinators, social workers, child life specialists, nutritionists, pharmacists, a donor program coordinator, and lab technicians. All are dedicated to treating not only bone marrow transplant patients, but also their families.

"The family is so involved," says Cowan. "You can't take care of the patient without the family, without the parents. Over time, you become more and more sensitive to families' concerns – and all the more committed to their care as a result."

That commitment couldn't have been more needed than it was by the Drakes. When they first met with Biljana Horn, MD, medical director of the Blood and Marrow Transplant Program, she told them Harry's chances could be as low as 10 percent. Katie and Julian debated whether or not to proceed with a bone marrow transplant.

They sought a second opinion from an AML expert at Stanford. He confirmed their options: take Harry home and just love him until he passed away, or put him through further grueling rounds of chemotherapy and a bone marrow transplant.

Cowan, a member of the UCSF Helen Diller Family Comprehensive Cancer Center, told the Drakes he wouldn't allow them to proceed with

PHOTOS: FROM LEFT: DRAKE FAMILY; DRAKE FAMILY; STEVE BABULJAK



October 16, 2008: Transplant day. Two years later, the Drakes asked the donor why he did it. He replied, “To save someone’s life.”



November 2008: “I kept thinking, one in 10 survive AML,” says Katie. “My mom said, “Somebody has to be the one in 10. Why not Harry?”



December 2008: Harry leaves his room for a quick drive through the BMT unit. “To be able to leave that room was such a blessing,” says Katie.

the transplant unless they were both in full agreement. After much agonizing discussion, they decided to go for it. “I didn’t want to look back and wonder: what if we had given him the transplant?” says Katie.

To prepare Harry, his cancer had to be in full remission, meaning more chemotherapy at CPMC, which thankfully proved successful. The Drakes checked into UCSF on Oct. 6, 10 days before transplant.

The bone marrow transplant (BMT) unit at UCSF Benioff Children’s Hospital sits behind a set of double doors in a positive pressure, high-efficiency, particulate air-filtered environment. That means when a door opens, instead of air flowing into the room, air flows out. The design is crucial to kids like Harry, who lack immune systems when they’re in the unit.

Each of the patient rooms is located off of an anteroom, where doctors, nurses, parents, and visitors must scrub up before entering. Patients cannot leave their rooms during the bone marrow transplant process, except for an occasional scan in another part of the hospital. At that time, a nurse carefully covers the patient in a sheet and escorts him or her to an elevator shared with no one else.

In the BMT unit at the new Benioff Children’s Hospital at Mission Bay – part of a state-of-the-art hospitals complex that will include women’s and cancer hospitals – a sophisticated design will allow patients to leave their rooms and walk unit floors. The new UCSF Medical Center at Mission Bay complex will open its doors in 2015.

Katie and Julian took turns spending 24 hours a day, seven days a week in Harry’s hospital room. “We couldn’t leave because of the need for isolation,” Julian reflects. “We had a beautiful view of the bay, and I watched the Blue Angels air show through the window. I remember looking down and seeing all the mountain bikers meeting at the corner of the street, ready to go for a ride. Life was going on without us.”

The parent not at the hospital stayed home to care for 3-year-old Jack, who couldn’t understand what was happening to his younger brother. Katie and Julian hadn’t even had a chance to explain it to him. “I was afraid of crumbling in front of Jack,” remembers Katie. “So I just put on a happy face for him, even though my thoughts were also with Harry.”

Because Jack was under age 12, he wasn’t allowed to visit Harry in the hospital. On one or two occasions, he came just to wave to his brother through the window on the door of the anteroom. “It was heart-breaking to see how much joy Jack brought to Harry, even through the glass,” says Katie.

Selective Donor Matching

Bone marrow transplant patients spend the 10 days from check-in to transplant undergoing a conditioning regimen: chemotherapy and possibly radiation therapy to kill their existing bone marrow cells and immune system, preparing their bodies to receive and accept the healthy donor marrow.

This acceptance is based largely on whether the donor and recipient cells think they’re the same – the likelihood of which can be gauged by comparing 10 genetic markers, known as human leukocyte antigens (HLAs), in the donor and patient. In general, the better these markers match up, the better the chance of marrow acceptance.

For Harry and every other child who receives a bone marrow transplant, there are several possible donor options. Allogenic transplant – cells from another person – is the option used most frequently to treat diseases requiring transplant in children. Siblings are usually the best allogenic donors, since they have a 25 percent chance of being identically



March 2009: The dressings for Harry's broviac catheter, which he wore from the day of his diagnosis until seven months post-transplant, had to be changed daily.



June 2012: The Drake family at home three-and-a-half years post-transplant. "At this stage, I am not worried," says Katie. "We know that we have other issues, but the fact that he is here is more than enough and will always be."

matched with the patient for all 10 HLA genetic markers.

When an HLA-matched sibling isn't available, alternative donors are sought, typically from among unrelated volunteers or the umbilical cord blood units of healthy babies that have been stored in special cord blood banks. While this option is used for an average 40 percent of children, it's not without obstacles: the search for these donors can take many months to complete and not everyone will have a match.

Cowan's team specializes in another, less common type of alternative donor – a relative (often a parent) who's only a half-match with the patient. To achieve success in these transplants, Cowan's lab enriches the donor's marrow stem cells while removing potentially harmful T lymphocyte cells that can cause a fatal reaction in the recipient called graft versus host disease.

For a minority of cancers, an autologous transplant can be performed, in which the patient's own bone marrow stem cells are extracted before a final round of marrow-killing chemotherapy and are then re-infused at the time of transplant. Since his was a cancer of the bone marrow itself, Harry was unable to have an autologous transplant; his brother wasn't a match, either. But a match was found – in an unrelated 25-year-old German miller who chops wood and raises sheep and goats for a living.

Transplant day fell on Oct. 16. At 1:32 p.m., the donor's peripheral blood stem cells trickled into Harry. "It was such a small amount of fluid," Katie remembers. "But so beautiful – a watermelon pink color."

The transplant lasted just 28 minutes. Katie recalls, "When it was over, I was like, 'That's it?'" – a very common reaction for families, according to BMT social worker Anu Sood. The day after the transplant,

Katie says, she and Julian thought: "Oh my God, we've done it. Now we have to live with what we've done."

Research and Clinical Innovations

Perhaps the hardest part is what loomed next: side effects of chemotherapy and the transplant.

Chemotherapy targets rapidly dividing cancer cells, but because the cells in hair, mouths, and intestinal tracts also divide quickly, chemotherapy tends to kill them as well. The result can be hair loss, stomach sensitivity, and mouth sores.

Harry suffered from the latter while receiving his second round of chemotherapy. With a bad case of mucositis, he was on so much pain medication that he lived in a deep sleep for his entire eighth month. When he did come to, he threw up mucus so long and thick that Katie could wrap it around her hand multiple times.

Following his transplant, Harry's side effects once again included mucositis – although fortunately not to the same degree – fevers, a staph infection, a strep infection, and a whole host of other issues. He also had to endure multiple blood transfusions.

Cowan and Horn have long been troubled by how the toxic effects of transplant regimens impact patients like Harry, and have spent the past 15 years studying ways to reduce them. Along with hematologist/oncologist Chris Dvorak, MD, they recently completed a trial using a combination of chemotherapy drugs that were less toxic and yet still effective. The trial was quite successful, benefiting multiple patients (including Harry).

Yet for recipients of less compatible, unrelated-donor grafts, the reduced toxicity of these drugs was associated with an increased chance of rejection. Dvorak has since developed a new approach, currently in trials, that will maintain reduced toxicity while overcoming the risk of rejection. In another trial, Horn is working to augment the chemo regimen by detecting the risk of relapse and harnessing the patient's own immune system to attack the malignancy.

Life Post-Transplant

A typical stay in the BMT unit lasts six to eight weeks. When the Drakes weren't released in time for Harry's first birthday on Thanksgiving Day, Katie prayed they'd be home for Christmas to see Jack open his presents in front of the tree. They finally checked out on Dec. 23, 11 weeks after checking in.

Four years later, the only residual sign of Harry's ordeal is that he resists feeding himself, a frequent problem for children who undergo a bone marrow transplant at such a young age. Harry had received nourishment through an IV or feeding tube from the time he was six-and-a-half months, so by the time he was released at more than a year old, he'd forgotten how to swallow and hadn't yet learned to chew. He has since learned to do both.

Two days a month, a cognitive behavioral therapist visits the Drake home to help Harry learn to eat. It's a slow process, but Katie and Julian have set a goal that seems easy to reach considering all they've achieved: they hope to see Harry feed himself when he enters kindergarten next year.

Aside from his eating challenges, Harry is a happy, active, carefree boy. Watching him splash through the creek at the neighborhood park, you'd never guess that he once had a 10 percent chance of survival. That his life was saved with a bone marrow transplant at UCSF. That he is a miracle. ■



NEW BONE MARROW TRANSPLANT UNIT

In the BMT unit at the new UCSF Benioff Children's Hospital, opening in 2015:

- Special entries will protect filtered air, letting patients walk unit floors
- Patient rooms (with two bathrooms) will be big enough for families
- Specialized play therapy space will let patients and siblings interact
- A family lounge will give parents a nearby place to unwind
- Nurses will be stationed around every corner
- Consult rooms and more support space will be on hand

FUTURE UCSF BENIOFF CHILDREN'S HOSPITAL



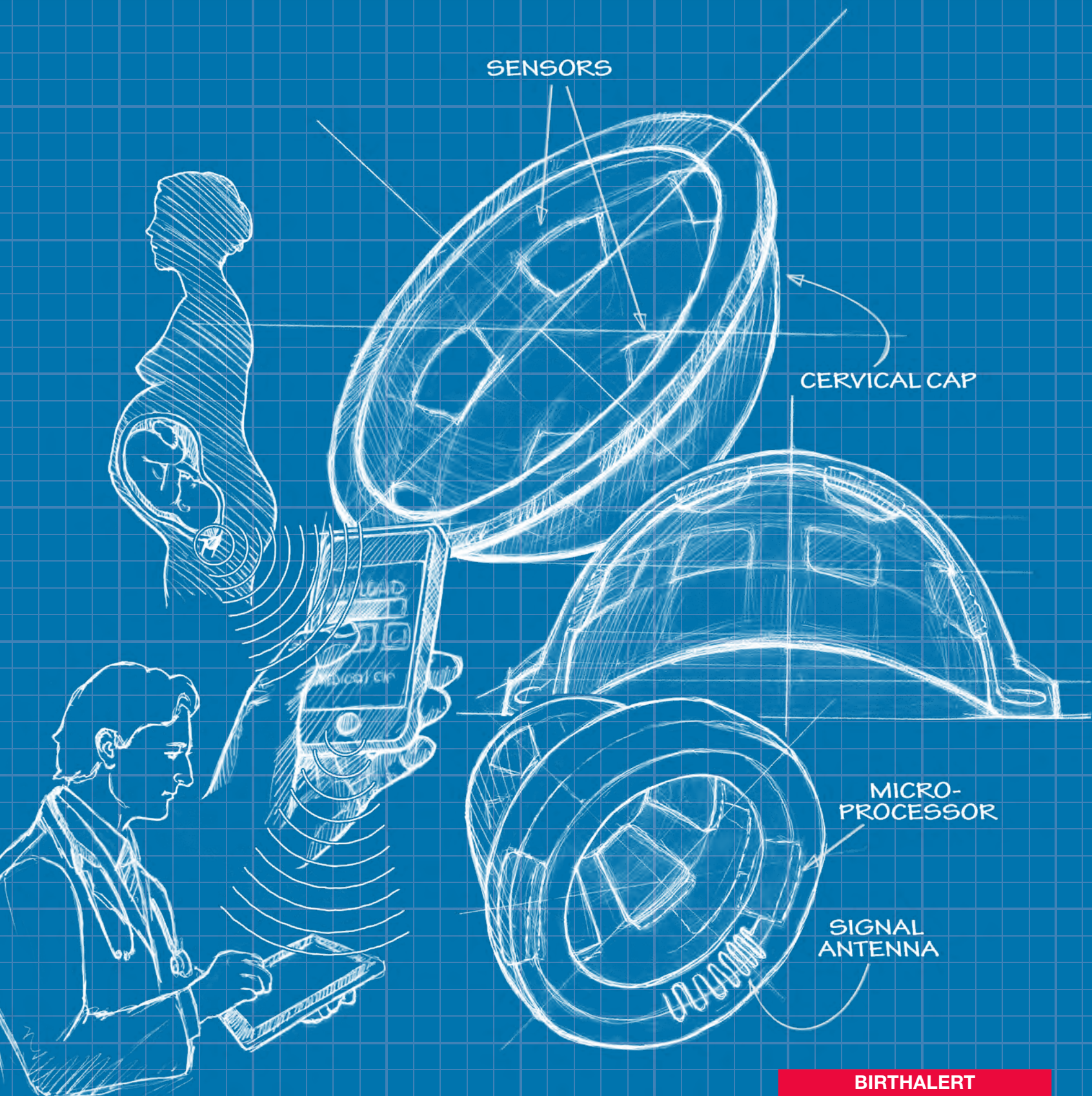

BIRTHALERT

BY OUR OWN DEVICES

Five inventors on five inventions that are changing the face of medicine

Innovation can be born of necessity, conscience, creativity, luck, or more likely, all of the above, all at once. Whatever the impetus, the active ingredient of invention is collaboration. The five scientists on the pages that follow – bioengineers Tejal Desai and Shuvo Roy, MD/PhD candidate Mozziyar Etemadi, microbiologist Joe DeRisi, and physician/surgeon Michael Harrison – trace intersecting paths, tapping each other’s expertise nearly constantly. When technology and need collide, Harrison sees alliances with engineers as a portal to a new realm of efficacy. “When we have a problem and there’s a missing piece, we don’t just wonder if someone will come up with it someday,” says Harrison. “We just go out and do it, together.”

By Claire Conway

DETECTING EARLY LABOR

Preterm labor is the number-one cause of infant mortality worldwide, taking the lives of 13 million babies a year. More shocking still is that the chances of having a preterm baby in the United States – one in eight – are greater than the global risk of one in 10.

These are the statistics that drive the BirthAlert team, which consists of a perinatologist, a mechanical engineer, an electrical engineer, and bioengineers. They're rethinking the way we detect labor.

"We've been predicting labor by the same measures – dilation and contractions – since the dawn of time," says Mozziyar Etemadi, an MD/PhD student in Shuvo Roy's bioengineering lab. "Once they set in, you only have 24 to 72 hours before the baby comes, and that can be too little time to intervene." This is especially true for women in the developing world who may be a long way from a hospital, according to Larry Rand, MD, leader of the BirthAlert team and director of UCSF's Perinatal Services and the Fetal Treatment Program. "In my work in Liberia, all too often I encountered women who came in contracting in the throes of preterm labor and were therefore stuck in their village," says Rand. "The only way out is often a 13-mile bike ride, which a woman in labor can't do."

The BirthAlert team has come up with a smart cervical cap that will monitor an earlier sign of impending labor – changes in the collagen of the cervix. Collagen, which is in many of our tissues, can be hard, like it is in our nose, or soft, as it is in our ears.

"During the course of a pregnancy, collagen in the cervix changes from rigid to soft, then the cervix opens. So the collagen essentially goes from gate to gateway for the baby," says Etemadi. Rigged with sensors, a small battery, and some wireless equipment to get a signal out to a phone, the device can be inserted briefly at home, once a day, without the aid of a professional. If softening is detected, the device will transmit a signal to a cell phone, which will then send the information to the physician. "The normal process of softening to opening takes anywhere from one to three weeks," says Etemadi, giving the physician a far wider window to work within.

Just exactly how much BirthAlert has widened the intervention window in high-risk pregnancies will likely be shown in the device's first clinical trials, which started in spring 2012 after receiving ethical approval by the UCSF Committee on Human Research. It's being tested in women deemed at risk of preterm birth, including those with previous preterm pregnancies and women over the age of 35 – all of whom will have BirthAlert inserted briefly for a reading during their regular prenatal visits.

If proven effective, BirthAlert may not only save millions of lives, but could also give better warning signals for the babies who do make it yet face a life of disability because of early birth, according to Rand. In addition, the device would reduce the formidable costs associated with preterm birth – an estimated \$26 billion a year in the United States alone. Estimated cost of the device: \$20 to \$30.

ENDING DIALYSIS

Be it financial, humanitarian, or ethical, the case for Shuvo Roy's artificial kidney is clear. Not only would the implantable, coffee cup-sized device eliminate the need for dialysis – which costs Medicare \$30 billion annually – but, as Roy notes, "It's impossible not to be moved by the plight of the patients."

Dialysis patients, the sickest of those diagnosed with end-stage renal disease (ESRD), can be hooked up to the machine as many as three days a week, three to five hours a session. "The annual mortality rate is around 20 percent, close to that of colon cancer," says Roy, PhD, associate professor in the Department of Bioengineering and Therapeutic Sciences, a joint department of the Schools of Pharmacy and Medicine.

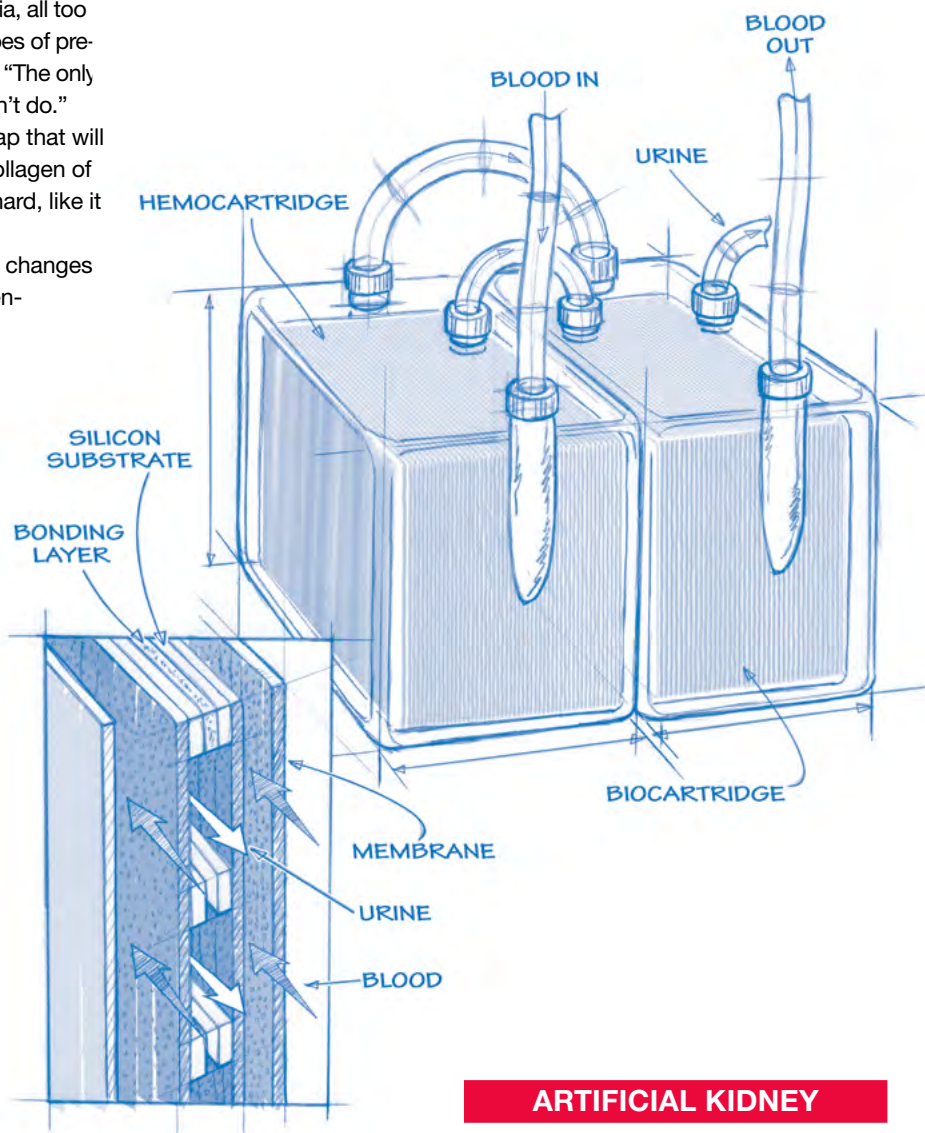

Dialysis patients are in desperate need of a rare commodity – kidney transplants. The statistics are devastating: 17,000 organs are available; 92,000 patients are in line. With ESRD rates increasing at 5 to 7 percent a year, the odds grow worse by the day, and the costs are enormous. This might explain why Roy’s kidney project qualified for the Food and Drug Administration’s Pathway Program, which essentially fast-tracks the approval process.

The device under development looks so simple – like an oversize nine-volt battery – yet a decade’s worth of dramatic bioengineering advances have shaped it. Surgically implanted into the abdomen to establish a permanent blood connection, it provides continuous therapy without immunosuppressant drugs.

The first major component of the device is the hemofilter, which uses silicon nanotechnology to produce a membrane that blocks toxins without causing clotting. The filter works at a pressure driven by the patient’s heart, eliminating the need for a power supply. The other major component, the bioreactor, mimics the metabolic and water-balancing duties of the kidney.

Building a successful bioreactor required a reliable supply of human-derived cells. “Silicon membranes had to catch up with the needs of the project. And we had to understand how to isolate the kidney cells and store them outside the body,” says Roy. “Those two developments combined with advances in materials for biocompatibility – the right coatings – are what make the device viable now.” Tejal Desai’s early work on the biocompatibility of silicon was, according to Roy, seminal in the field of miniature implants in general and, more specifically, critical to the long-term success of the device.

So far the proof-of-concept components of the artificial kidney have worked successfully in small animals, and extended studies are planned for the immediate future. With a green light on these studies and adequate funding, Roy expects human trials to begin in five to six years.

DIRECTING DRUG DELIVERY

Picture this: as you approach your front door, it looks oddly crooked. On the other side stands your spouse, whose face seems wavy and distorted. These are among the unnerving first signs of age-related macular degeneration (AMD), the leading cause of blindness in people over 60. Although new drugs can stop AMD’s progression, physicians have struggled with getting them to the right place inside the body.

Tejal Desai has a tiny solution. “I attended a forum shortly after I came to UCSF, where several ophthalmologists talked about challenges in their field,” recalls Desai, PhD, professor in the Department of Bioengineering and Therapeutic Sciences, a joint department of the

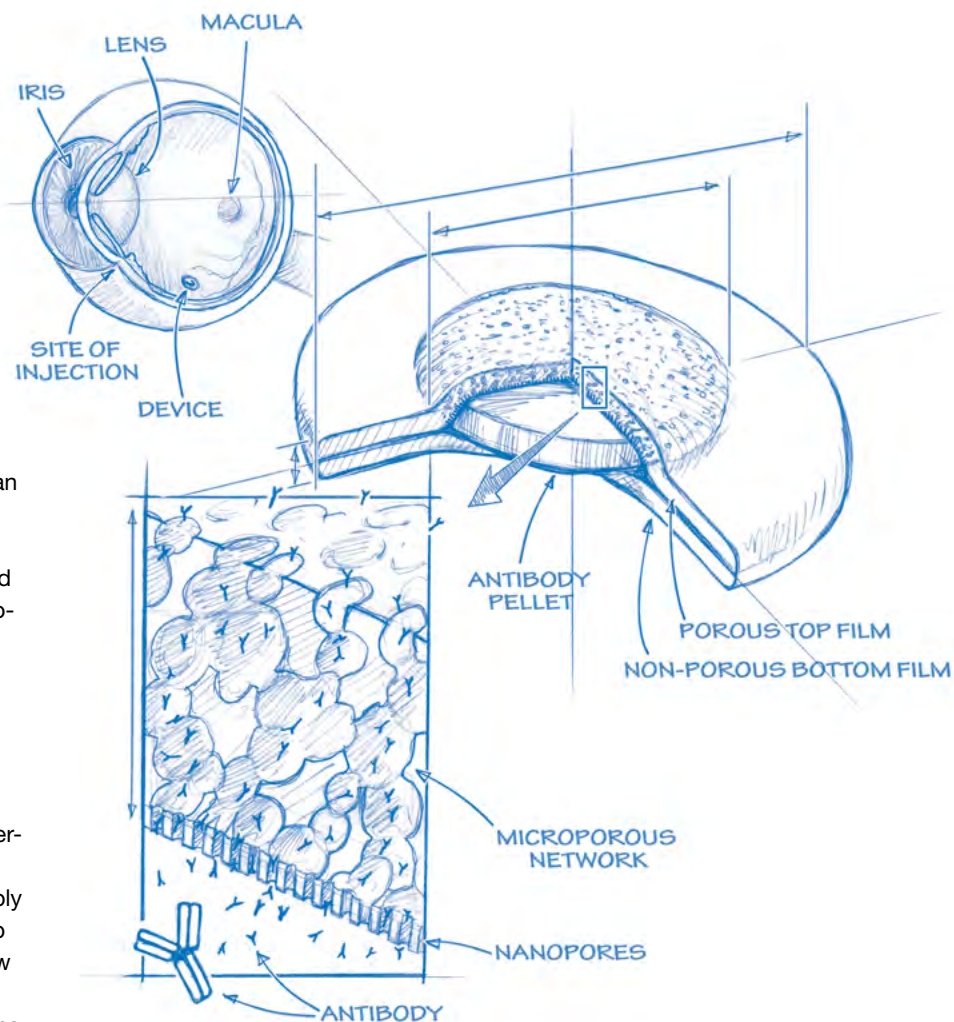

DRUG DELIVERY DEVICE

Schools of Pharmacy and Medicine, and co-director of the Master’s in Translational Medicine program. When it was the engineers’ turn to discuss what they do, she described her work: using nanofabrication technology to create a microscopic drug delivery device, chemically engineered to release interferon over several months, as a treatment for hepatitis patients. “An ophthalmologist came up to me at the wine and cheese gathering afterwards and said, ‘If you could do that within the eye, it would be a major revolution.’”

That was three years ago. Now Desai has partnered with the ophthalmologist who approached her – Robert Bhisitkul, MD, PhD – to create a prototype and file a patent for a drug delivery device for macular degeneration. Currently, the only way to get a drug to the retina is to inject it directly into the area. “Because injected drugs actually break down and clear away quickly, patients have to have the injection monthly,” says Desai. “We are developing a polymer thin film that is injected in the back of the eye and can deliver drugs for at least six months at a time.” The film eventually biodegrades, and patients return for another injection.

The device has the potential to make a substantial impact. “One, you’re able to use less drug, so there will be major savings in pharmaceutical costs in the health care system,” explains Desai. “Two, with a more direct delivery, you get a more effective response. And three, you get fewer side effects because you’re using less drug.” The device is currently being tested in animal models; human trials are expected in three to five years.

Desai’s next frontier – diabetes. Since very little (less than 5 percent) of a drug taken orally actually makes it into the body, these patients are forced to endure daily insulin injections. “The insulin would be broken down in the intestine before hitting its target site,” she says. She’s now working on an artificial pancreas housing cells that can sense and respond to changes in blood glucose, doing away with insulin injections for a lifetime.

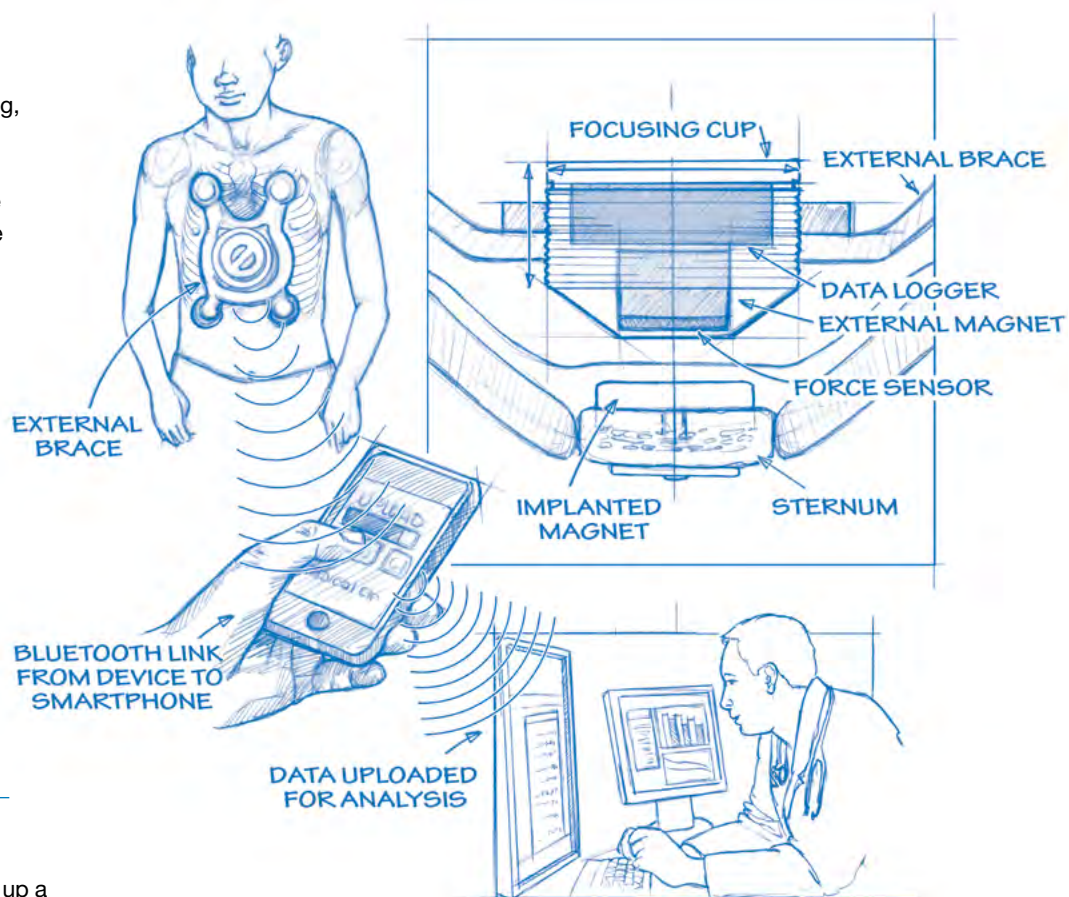

EASING BREATH

Necessity has been the mother of all of Michael Harrison’s inventions. As co-founder of the UCSF Fetal Treatment Center, Harrison, MD, has racked up a list of devices that changed children’s lives before they took their first breaths.

“The whole field of fetal surgery was built around the innovation of devices,” says Harrison. Take the early surgical stapler: tests showed that using metal staples to close a uterus caused infertility in animals. “It was a shocking revelation, so I worked with a company on the East Coast for a year to solve the problem,” he recounts. “They came up with a stapling device that became the enabling agent for fetal surgery. That device is what made fetal surgery real.”

Likewise, need forced the invention of tools for the minimally invasive procedures of fetoscopic surgery, where surgeons operate with elongated tools and scopes, following their movements on a screen. “The instruments – traditional scissors and graspers but on long sticks – were part of the explosive era of innovation between 1980 and 1990,” says Harrison. “They’re used not just for fetal surgery but for any arthroscopic procedure.”

Harrison is still at it, inventing devices for an underserved population – children. His latest, the Magnetic MiniMover, is innovation born of conscience. It’s designed for kids who suffer from a condition called sunken chest, which can compress and damage the lungs and heart. “All we have to fix sunken chest is a terrible operation, where we rip a child’s whole chest wall apart and put it back together with a steel bar,”

MAGNETIC MINIMOVER

says Harrison. “I knew we had to work with a different principle.”

His solution, the Magnetic MiniMover, works by perpetual force, much like braces work to correct a child’s crooked teeth. In an outpatient procedure, Harrison surgically implants a magnet in a child’s sternum. He then gives the child an opposing magnet to wear at night, or even during the day under clothing, to slowly but surely draw the chest wall outward. Harrison worked with Mozziyar Etemadi and Shuvo Roy to rig the device with sensors that send messages about usage and pressure to the child’s physician, via cloud database technology. The device is now in clinical trials.

As is the case with most pediatric devices, the impact appears small on the surface: only 2,000 children a year are diagnosed with the disease. “This is a good example of why it’s so challenging to develop a pediatric device,” explains Harrison. Yet the US Congress considers the need to be great – leading it to mandate the creation of a Pediatric Device Consortia Grant Program to stimulate the development of these

devices. Harrison directs the UCSF branch of the consortium. “No big company is going to invest, because there’s no pot of gold at the end of the rainbow. But there will be a safe treatment that’s a whole lot better than the old one.” And that’s more than good enough for Harrison.

ISOLATING VIRUSES

The global impact of Joe DeRisi’s ViroChip is measured in what hasn’t happened. The device holds DNA samples of every known virus on the planet (there are 22,000). Within minutes, the ViroChip can detect any virus – like severe acute respiratory syndrome (SARS), which DeRisi worked with the Centers for Disease Control to identify in 2003 – leading to its isolation and containment, and potentially preventing a pandemic.

Since SARS, several new viruses have been identified by the ViroChip, including some associated with diseases like gastroenteritis and severe respiratory disease – two of the biggest killers of children under 5 years of age. “The ViroChip has called into question the role viruses may play in cancer and other diseases,” says DeRisi, PhD, co-chair of the Department of Biochemistry and Biophysics and a Howard Hughes Medical Institute investigator at UCSF. “Are they causal, or do they just coexist? We can’t say yet, but it’s a question worth asking.”

Looking like little more than a microscope slide, the ViroChip relies on DNA to make match-ups. When the DNA in a patient culture, which is labeled with a fluorescent, sticks to its corresponding virus DNA on the slide, matches are made – and many a mystery has already been solved.

DeRisi, who not only built the ViroChip but the robots that assembled it, is now working on software technology that will push the library of bioinformatics currently available to sequence vast quantities of biologic material, mining for viruses. “The idea is, here are some sick people, and the sickness could be contained in one area of the body – say the gut,” says DeRisi. “In this case, we’re sequencing everything that’s there, looking for the needle in the haystack – the virus.”

DeRisi believes the technology will be a lens to a whole new viral frontier. “With the ViroChip, we can find viruses that are close enough to known viruses to be recognized,” he explains. “In our new system, we have pulled up viruses that look so different, we weren’t sure they were even viruses. We’re building software that’s able to put the pieces together and confirm they are.” ■

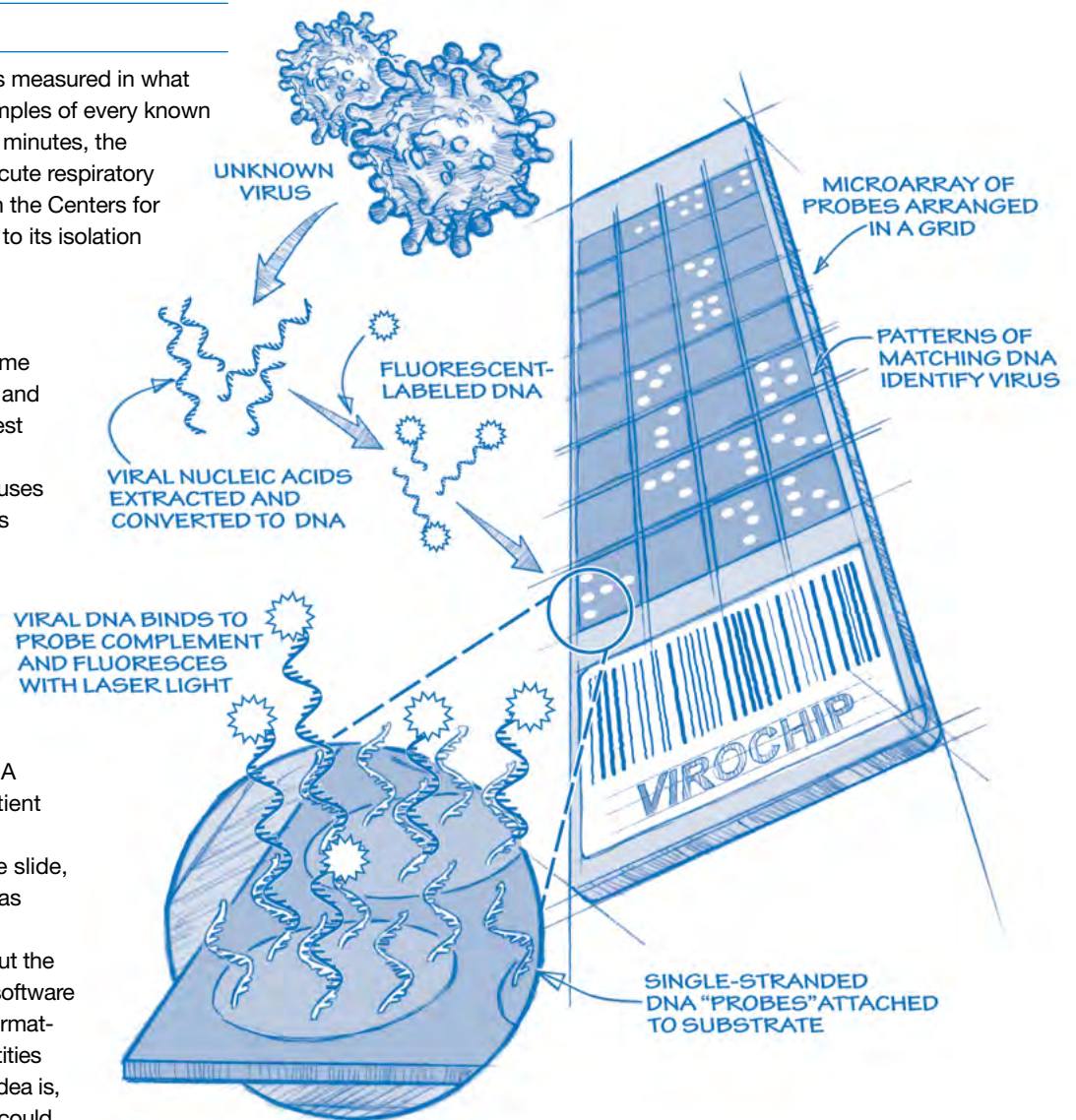

VIROCHIP

UCSF at Work in the World

Spin the globe and pick a nation. Chances are you'll find UCSF faculty, staff, and/or students striving to better the health of those who live there. Some 1,200 are working across the world to uncover root causes of diseases that plague developing countries, offer care where it's scarce, train fellow health care providers, shape policy, and more.

Helping harness their diverse talents and prodigious output is UCSF Global Health Sciences (GHS). Led by Jaime Sepúlveda, MD, MPH, DrSC, GHS integrates UCSF's expertise in all of the health, social, and biological sciences to improve outcomes and reduce the burden of disease in the world's most vulnerable populations – whether in the heart of San Francisco or the far reaches of Asia.

We spun the globe ourselves – and here are just a few of the many UCSF projects underway.



SAN FRANCISCO | Facing a Viral Foe

Hepatitis C is endemic among young injection drug users – a segment of the population that appears to be growing globally. At the Tenderloin Clinical Research Center, epidemiologist Kimberly Page, MPH, PhD, leads a team that is testing a new vaccine to prevent hepatitis C. The team provides outreach, screening, referrals to mental health and drug treatment programs, and prevention counseling for the clinic's patients. Patients who test positive for the virus are referred for medical follow-up. With funding from the US Centers for Disease Control and Prevention, Page is developing guidelines so that other cities can adopt the center's model of outreach and care for young adults who inject or are at risk of injecting drugs.



GUATEMALA | Fighting a Global Killer

Biomass cooking stoves are nearly ubiquitous in rural Guatemala and common in much of the developing world. Nurse and environmental scientist Lisa Thompson, RN, FNP, PhD, helped conduct the first randomized intervention study of the effects of exposure to household air pollution (HAP) generated by these stoves on childhood pneumonia. She is now examining how HAP impacts birth outcomes and child neurodevelopment, and has trained traditional Guatemalan birth attendants to help gather data.



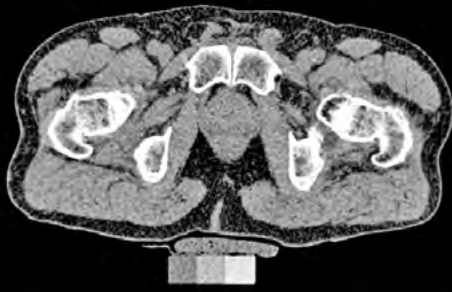

ICELAND | Learning Genetic Secrets of Longevity

Iceland is the site of AGES-Reykjavik, one of the world's most extensive epidemiological studies. Short for "Age, Gene/Environment Susceptibility-Reykjavik Study," AGES-Reykjavik was designed to examine risk factors, including genetic susceptibility and gene/environment interaction, in relation to disease and disability in old age. A partner in the effort, the National Institute on Aging, recruited UCSF imaging expert Thomas Lang, PhD, to help design the study's musculoskeletal imaging component. Lang developed the software that enabled the researchers to read and analyze complex CT images of the 5,500 participants, and the repeat images, some years later.



CHINA | Caring for Kids

In China, one in 350 children is born with a cleft lip and palate. Orthodontist Karin Vargervik, DDS, has helped to develop three treatment centers and is staking out a fourth. Working with Alliance for Smiles, a San Francisco volunteer organization, she is applying UCSF's comprehensive, team-based approach, involving primarily surgeons, speech pathologists, dentists, and orthodontists. Over the course of her seven-year involvement with Alliance for Smiles, Vargervik has facilitated the training of Chinese professionals, at times on the UCSF campus, and ensured the treatment of hundreds of Chinese children – free of charge.

SWAZILAND | Eliminating Malaria

Based on its recent success in controlling the spread of malaria, the government of Swaziland shifted its strategy from controlling to eliminating the disease by 2015. They turned to the Global Health Group – part of UCSF Global Health Sciences – led by Sir Richard Feachem, PhD, DSc(Med). With assistance from the Global Health Group's Malaria Elimination Initiative and partners at the Clinton Health Access Initiative, Swaziland has launched a sophisticated malaria elimination campaign that combines high-tech tools like GPS mapping and a mobile-phone reporting system with the in-person work of active case detection.





William Seeley,
brain navigator and
MacArthur genius

William Seeley maps the path of frontotemporal dementia through the brain, correlating specific damage with behavioral change. By studying the disease from self to circuits to cells, this visionary neurologist searches for inroads to treatment.

By Claire Conway

Identity Theft

The people we love are the sum of countless parts. A calm steadiness, outsized laugh, ready wit, meticulous aesthetic: it can be hard to recall every trait that draws us in. And yet these traits are never more obvious than when they disappear, bit by bit, as they do in people with behavioral variant frontotemporal dementia (bvFTD). In its punishing trajectory, the disease tears away at all we associate with identity, rendering someone a fragment of his or her former self.

Radical changes in personality happen along bvFTD's destructive course, which runs the better part of a decade. Lifelong Republicans become Democrats or vice versa; agnostics find religion; aggressive types grow placid and apathetic; sensitive souls become callous or tactless. Empathy and social skills deteriorate until, ultimately, patients with bvFTD are unrecognizable to their loved ones, a heartbreaking transformation that can make caretaking profoundly difficult.

William Seeley, MD, a neurologist at UCSF's Memory and Aging Center, documents each stage of bvFTD – part of a neurodegenerative disease family that's the leading cause of dementia in people under 65 – with painstaking precision, seeking a way to stave off his patients' disappearance. These patients are a focus of the center's multidisciplinary teams, in which neurologists, psychiatrists, geriatricians, neuropsychologists, nurses, speech pathologists, social workers, genetic counselors, and pharmacists work together to combat a broad range of diseases that cause cognitive impairment.

Seeley, a 1999 graduate of UCSF's School of Medicine, hopes to correlate the behavioral changes he notes with subtypes of the disease, as well as to changes occurring in the brain. Using functional magnetic resonance imaging (fMRI) and tissue analyses, he has already made a critical discovery: bvFTD targets the von Economo neuron (VEN).

Romanian-born neurologist Constantin von Economo wrote with remarkable foresight about the spindly-shaped neurons that bear his name in his elaborate brain atlas, co-authored with George Koskinas and

published in 1925. The trailblazing scientist identified VENs in two regions of the brain – the anterior cingulate gyrus and the frontoinsula cortex. Though a good distance apart, the regions are alike enough on a microscopic level that von Economo hypothesized they were functionally similar.

“In my favorite paper of all time, von Economo speculated that the frontoinsula cortex might be the part of the brain that receives all the incoming information from the body about its immediate condition – feelings we experience like the beating of our heart or butterflies in our stomach – an idea that is now becoming widely accepted in neuroscience,” says a grateful Seeley. “He was way ahead of his time.”

Evidently, so is Seeley. One hundred years after von Economo started his atlas, Seeley was named a MacArthur Fellow for his own multi-dimensional maps of the cerebral environs that VENs inhabit. Nicknamed “genius grants,” the fellowships are given to the approximately two dozen people across the United States who have demonstrated “extraordinary originality and dedication in their creative pursuits.”

Seeley's genius status was cemented when news of his fellowship hit *The New York Times* in September 2011. He and his wife, Hilary, were on the maternity ward of UCSF's Moffitt Hospital when the messages began flooding in.

“My daughter was seven hours old, and we had all just shared the pink light of her first sunrise when my phone lit up with messages from everyone I had ever known on the East Coast,” says Seeley. “I'm pretty sure I am the only MacArthur Fellow for whom the news came as the second best thing to happen that day.”

Surveillance: Three-Dimensional Mapping

Seeley's maps cover uncharted territory by layering three dimensions on top of one another: behavioral, cellular, and neural networking. To build a patient map, he begins by collecting behavioral observations – directly

and via anecdotes from family members. Then he scans the brain to track neural activity.

“Through fMRI, we’re developing brain imaging strategies for understanding the crosstalk among the brain regions,” says Seeley. “Over the course of an eight- to 10-minute scan we can identify areas that are synced and wired up together into networks.”

Seeley hopes his fMRI surveillance will allow him to monitor glitches or slowdowns in this crosstalk between intrinsically linked areas of the brain, even before he begins to detect their shrinkage (the conventional measure of degeneration). These communication breakdowns could be the tip-off to the VEN (cellular) disintegration that causes neural networks to fray and behavior to deteriorate – a three-dimensional corrosion.

“It’s as if the patient has simultaneously
lost the gas pedal and the brakes.”

“That’s the same patient showing a complete failure to act when action is needed,” says Seeley, “or a complete failure to suppress an unwanted action when stimuli are just attractive enough to draw the patient’s behavior toward the target, the little girl. It’s as if the patient has simultaneously lost the gas pedal and the brakes.”

Longitude: Neural Networks

According to Seeley’s maps, both responses of the patient in the mall could be correlated to the same lesion in the brain – one that interrupts communication systems.

“At any given moment, we’re bringing potential actions into consciousness and weighing the emotional consequences of each action’s

predicted outcome,” says Seeley. “We use those anticipated reactions to decide whether or not to act.” Patients with bvFTD have a break in that feedback loop, which quiets or silences the signals of the social and emotional navigation system that advises them whether to apply the gas or the brakes.

The regions involved are exactly those that intrigued von Economo: the fronto-insular cortex

and the anterior cingulate gyrus. Just as von Economo speculated, the fronto-insular cortex receives all of the autonomic responses regarding the body’s condition – the quickening of our pulse that tells us we’re afraid, the goose bumps on our arms alerting us we’re cold – that we experience as feelings.

This region is intrinsically connected by critical communication corridors to the anterior cingulate gyrus – the output pathway driving behavior, which would normally compel the patient to help the lost girl after receiving a distress call from the fronto-insula.

The disease can be a decade-long scourge of degeneration in these regions. The fronto-insula and anterior cingulate deteriorate along with the communications between them, causing patients to veer far off the beaten social path. Tactless and impulsive acts can be as abundant as they are outrageous, including sexual deviance or verbal assaults on strangers. Some patients have been known to go out in 80-degree weather in a heavy parka and end up dehydrated in an emergency room. Others may eat and eat to the point of sickness and obesity.

“The heatstroke, overeating, and tactless behaviors can all be understood within this framework of the patient’s inability to represent the moment-to-moment state of the body and act based on those internal cues,” says Seeley.

For now, the only treatments Seeley can offer his patients and their families are antidepressants and anti-anxiety drugs to help control behaviors like overeating or compulsivity. Seeley also talks through

Latitude: Behavior

In contrast to Alzheimer’s, which hits later in life and launches a slow attack on memory, bvFTD starts early and moves fast, erasing not memories so much as self.

“My Alzheimer’s disease caregivers almost always say that their loved one is still there, to the end,” shares a noticeably moved Seeley. “This is not the case for my bvFTD caregivers.”

Digging deeper into the details of his map dimensions, Seeley combines anecdotes from various patients to describe the quintessential behaviors of someone early on in the disease. “Say the patient is walking in a mall and sees an 8-year-old girl standing alone, looking concerned,” says Seeley. “Normally, that would induce a little alarm signal: ‘Child in distress...take action to solve problem!’ But the patient passes right by. Now imagine the 8-year-old standing happily with her mom in the mall. The patient might go up to the girl, pat her on the head, and take a lick of her lollipop.”

behavioral strategies, such as placing locks on kitchen cabinets and passing out note cards in public explaining that the patient is struggling with an Alzheimer's-like illness that affects behavior.

Prime Meridian: von Economo Neurons

Seeley's optimism is in the final, cellular layer of his maps, where he sees protein targets just begging for the right therapeutic weapon. Postmortem studies of bvFTD patients show they have one of three lethal proteins in their brains: tau, TDP-43, or FUS.

"Each of these proteins normally lives in nerve cells. In bvFTD, the proteins misfold, clump together, and disrupt neuronal function, including that of the VENS," explains Seeley. While he hopes to create a behavioral profile that might match each offending protein, he fears that the differences might be too subtle, making it difficult to hone in on an individual protein. "What we really need is a blood, urine, or imaging test that tells us with 100 percent certainty which protein is present, so we can find a specific drug to target each one."

Some patients have a clear family history of the disease, which can be pinpointed using a blood test for disease-causing genetic mutations. This patient subset represents 10 to 20 percent of the larger FTD population. "These families are our greatest hope," says Seeley.

Patients with mutations in the tau gene will soon, Seeley explains, participate in clinical trials of tau-inhibiting therapies, which he hopes will prevent the disease from devastating yet another generation of each patient's family. The drugs could also have enormous implications for patients with Alzheimer's disease, whose brains are ravaged by both tau and another protein, amyloid beta.

The families of his patients are squarely behind Seeley, appreciative of all he's done so far. In fact, many of the messages he received during his daughter's first sunrise were congratulations from those families. "The most touching emails were from my former patients' widows, widowers, and children, saying, 'I remember our time with you, and it made a difference. Keep on doing what you do,'" he says with a long exhale.

Seeley speaks with urgency when describing the difficulty in treating people who can't advocate for themselves. "Cancer docs have had to take on the idea that they will make their patients worse before they make them better," he says. "Their patients willingly take the risk of enduring toxic blasts of chemo and radiation to save their lives."

Yet asking his bvFTD patients to take such risks is inherently harder when Seeley can't know if they even understand his question. But he can guess how the children of his patients might answer, if they knew bvFTD was their destiny. And he certainly knows what his own answer would be.

"If I knew ahead of time I would contract this disease, I'd want to take any risk to stop it. In the search for treatments, we have to push past that ingrained do-no-harm reticence," he says. "Progress almost always involves risk."

Channeling his oncology colleagues, Seeley is embracing risks well worth taking. "We are working with our industry partners to move promising treatments forward. There's a lot to be hopeful about." ■

A PARALLEL WITH AUTISM

The blush of red corresponding to brain activity on Seeley's fMRIs has cast new light on the social brain. He and others in the field are drawing parallels between the brains of his patients who become deaf to social cues and the brains of children with autism who struggle to learn them in the first place. "There's a striking correlation between autistic spectrum traits and the cingulate's connectivity with the insula," says Seeley.

Some patients with FTD – primarily those with a form that attacks the language system – can also develop the savant-like behaviors similar to those on the autistic spectrum. In these patients, untapped parts of the brain light up as other regions degenerate, giving them new and extraordinary creative talents.

"One of our patients was a biologist who picked up a paintbrush for the first time about eight to 10 years before her first misspoken word," says Seeley. He collaborated with Memory and Aging Center Director Bruce Miller, MD, to publish a paper about the woman. "Even when she had become mute, she was still creating beautiful paintings."

Seeley believes a push-and-pull relationship between brain systems is at work within these patients. "I think of the woman's drive to paint as an early indicator of her brain changing and pushing her toward that behavior," he speculates. "As her frontal language system began to wither, its role in suppressing activity in her visual brain began to fail, creating a richer visual experience and compelling her to paint."

Seeley sees opportunities like this – to think about the neural origins of creativity – as a bonus. "The fact that we get to think about self, creativity, emotion, sociality, and all those really fascinating things about the brain along the way...that's gravy for me," he says. "But we don't ask these questions out of simple curiosity. Everything we do is meant to move us toward curing or preventing disease."



Major General Ted Wong, a School of Dentistry graduate, checks in with a patient using the Intrepid Dynamic Exoskeletal Orthosis – an indispensable rehabilitation technology developed at one of the medical centers under his command.

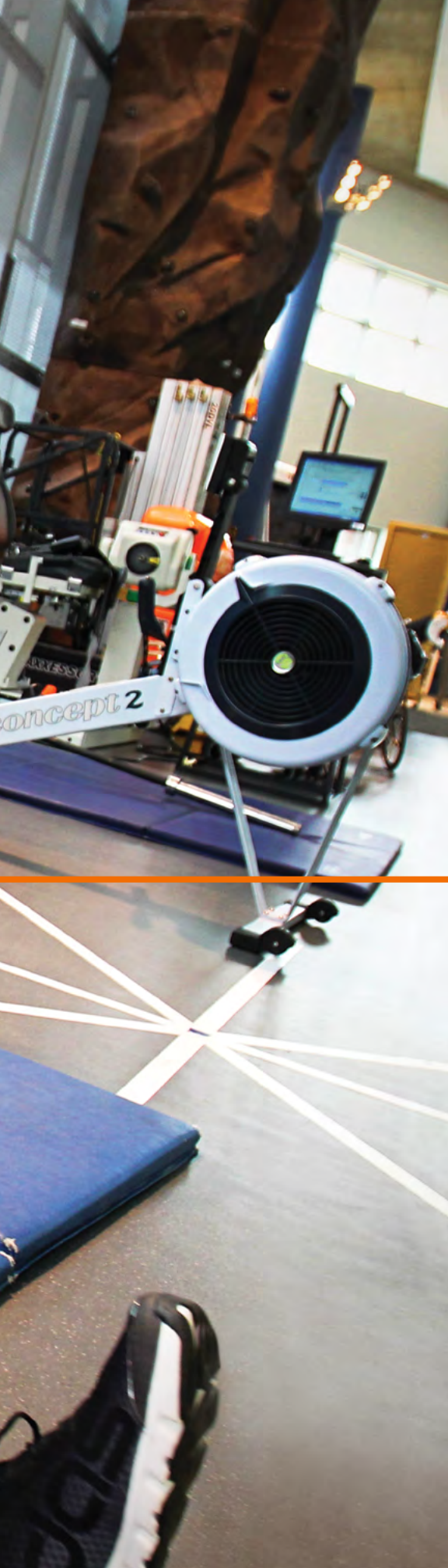

PHOTO: JENNIFER WHITNEY

PUTTING PATIENTS FIRST

Award-winning scientists, university chancellors, presidents of health care organizations, chief executive officers, deans of colleges, commanding generals: UCSF has a history of producing alumni who become leaders in the health sciences. Here we highlight four – one each from the schools of dentistry, medicine, nursing, and pharmacy – who are making a difference in the lives of patients around the country and the world.

By Kate Volkman

SUE CURRIN, RN, MS '93

CEO, San Francisco General Hospital and Trauma Center

Sue Currin's first encounter with San Francisco General Hospital and Trauma Center (SFGH) was as a college-age patient – receiving treatment for a stab wound to her hand made by a mugger. Little did she know she'd end up spending most of her career there. And what a career it's been: last year, as CEO of SFGH, Currin hosted US Department of Health and Human Services Secretary Kathleen Sebelius, who called SFGH a model for providing better care at lower costs to patients.

As a public hospital, SFGH's mission is to provide quality health care and trauma services with compassion and respect. It's a level 1 trauma center – the only trauma center in the City and County of San Francisco – and the area's sole provider of psychiatric emergency services. With 598 licensed beds, SFGH supplies 20 percent of the city's inpatient care and treats 102,000 patients per year. Forty percent have Medi-Cal, 22 percent have Medicare, and almost all of the rest are underinsured or uninsured. Each of the hospital's physicians is also a faculty member at the UCSF School of Medicine.

Everything Currin and the SFGH staff do is focused on putting patients first.

The hospital's video medical interpretation system is a prime example. More than 20 languages are spoken at SFGH on any given

day, so interpreters visually join the patients who require their services, and their care providers, in a room via computer monitor. Improving on telephone interpretation, video allows for interpretation of body language; plus, the program eliminates travel time and saves costs by sharing interpreters with Alameda County.

Patients were also top priority when creating the new, seismically safe SFGH currently under construction. Set to open in 2015, the facility was designed with input from physicians, nurses, social workers, and therapists. Among their key requests: install a handrail to guide patients

“It's not about having more patients in beds; it's about keeping them out of beds.”

from bed to bathroom, reducing the high incidence of injury that occurs in that short distance; configure each room the same way, so in an emergency nurses and physicians won't get disoriented and can focus their full attention on the patient; and design adaptable rooms to decrease the need to move patients between medical-surgical, intermediate, and critical care.

Currin and her team recently completed a five-year strategic plan, shifting the hospital's vision from building a new facility, since it's now underway, to advancing community wellness. “It's not about having more patients in beds; it's about keeping them out of beds,” she says.

To that end, SFGH has developed a wellness program, including exercise classes, a smoking cessation program, cooking demonstrations, and increased vegetarian options on hospital menus.

Soon after Currin's first experience as a patient at SFGH, she earned her nursing degree and became a staff nurse at the hospital. Several years and a promotion later, she realized that to be able to do more for her patients, she needed to return to school. She decided on the UCSF School of Nursing for her master's degree.

“I could have gone to other nursing schools, but UCSF was really the best,” Currin reflects. “They had great professors and mentors that really inspired a whole generation of nurses. If you look at the alumni, a lot of them have become leaders.”

Including Currin. MS in hand, she returned to SFGH; 16 years later, in 2009, she was appointed CEO.

“I have to say, being CEO is better than I could ever have thought,” she says. “Especially a nurse and CEO – I'm able to influence the priorities for the whole organization and have a voice at the table in the Department of Public Health. I can keep people focused on what's right for patients and impact an entire community.”



KATHLEEN KENNEDY, PHARMD '78

Dean, Xavier University of Louisiana College of Pharmacy

If it weren't for UCSF School of Pharmacy's minority recruitment program, Kathleen Kennedy might never have entered the school. If it weren't for then Professor, now Dean Emeritus Mary Anne Koda-Kimble, PharmD '69, suggesting that Kennedy would make a good teacher, she might never have considered a career in academia. And if it weren't for a talk at UCSF about health disparities by a professor from Xavier University of Louisiana College of Pharmacy, she might never have applied for a faculty position there. Now, thanks to all of those circumstances, Kennedy finds herself dean of that same college.

Xavier University of Louisiana is a historically black school in New Orleans. The mission of its College of Pharmacy is to prepare pharmacists to impact the medically underserved, particularly the African American community, in an effort to eliminate health disparities through patient-centered care, community service, and scholarly work. It offers just the PharmD degree and counts more than 600 students in its program. Students in the class of 2014 are highly representative of the underserved populations many will go on to support: 38 percent are African American, 34 percent Asian, 22 percent Caucasian, 2 percent Hispanic, and 3 percent other.

Drawing on her residency experience at UCSF, the school that pioneered clinical pharmacy, Kennedy established a clinical pharmacy program at Xavier. "The concept of clinical pharmacy was entirely

"If you can't relate to your patients, you're wasting your time."

foreign to the South, so the first time I showed up for rounds, the physicians asked, "Why are you here?" remembers the Tennessee native.

This confusion persists today, and Kennedy considers it part of her mission to communicate about and demonstrate the role pharmacists can play in improving patients' health outcomes. She's particularly interested in underserved minorities and has worked to improve their health outcomes, partly by teaching cultural competence – the ability to interact effectively with people of different cultures. "If you can't relate to your patients, you're wasting your time," she explains.

When Kennedy was named associate dean at Xavier in 2002, she helped establish the Center for Minority Health and Health Disparities Research and Education. It focuses on diabetes, asthma, and cancer. "We have pharmacists in a lot of the clinics in underserved areas," she says. "They're making a big impact, because, for example, when a physician sees a patient who doesn't control his diabetes, the pharmacist can show him how to use a glucometer."

In 2007, through the federal funding Xavier receives to support the center, Kennedy organized the first annual national conference on



health disparities. It was designed for mid-level health care professionals, and she intended it to be a place where they can share knowledge – with the goal of impacting policy and changing behaviors to improve minority health outcomes.

Last year, Kennedy's career-long effort to encourage outstanding pharmaceutical care and training within a cultural context resulted in one of pharmacy's highest honors: the Rufus A. Lyman Award, presented to her by the American Association of Colleges of Pharmacy (AACP) for her publication on students' perceived level of cultural competence to guide curriculum development.

To improve her own professional outcomes, Kennedy completed the Management Development Program at Harvard University's Graduate School of Education in 2004 and the Leadership Fellows Program with AACP in 2006. She was appointed interim dean of Xavier's College of Pharmacy in 2009 and was named dean in 2010.

Kennedy never imagined that one day she'd hold her current position. "I thought all deans did was shake hands and raise money," she says. "Then I saw that it was so much more than that. It's about getting to set the direction for the college."

MATTHEW SPITZER, MD, RES '98

*Immediate Past President, Médecins Sans Frontières/
Doctors Without Borders – USA*

Upon graduating from Cornell University Medical College (now Weill Cornell) in 1995, Matthew Spitzer was excited – and driven – to start his residency. He matched at UCSF for the family medicine program at San Francisco General Hospital and Trauma Center (SFGH). “It has an extremely diverse and mostly underserved patient population,” Spitzer says – and treating underserved patients was his motivation for pursuing a career in medicine.



SFGH proved to be the perfect training ground for Spitzer’s later work with Médecins Sans Frontières (MSF)/Doctors Without Borders. “I thought the General was amazing,” he recalls. “The staff is so incredibly motivated and connected to the patients.”

MSF delivers emergency and urgent medical care to people affected by armed conflict, epidemics, health care exclusion, and

natural or man-made disasters – providing this care irrespective of race, religion, gender, or political affiliation. Founded in 1971, it works in nearly 60 countries and has over 25,000 people in the field.

In 1999, after completing his training and practicing in California for a year, Spitzer received his first MSF assignment: Khampa Tibet, southwestern China. The remote rural area had suffered from severe frost, food shortages, and an almost complete collapse of basic health care. His job was to establish primary care services and train local medical providers. In one situation, he treated a woman who still had not passed her placenta two days after giving birth. “To be present for those in need – I see this as fundamental to what it means to be a doctor,” he says.

Many more lifesaving assignments awaited Spitzer. In 2001, he transitioned to MSF-USA, exploring the medical needs of asylum-seekers detained by immigration authorities in the New York area. He returned to the international field in 2002, serving in Moyamba, Sierra Leone, soon after that country’s civil war ended. But war in neighboring Liberia had just erupted, and refugees poured across the border. Before MSF arrived, the huge district of 500,000 people had only two doctors. Spitzer’s team included seven MSF staff and 120 local staff for the district hospital and Taiama refugee camp, where they fought intense endemic malaria and

“To be present for those in need – I see this as fundamental to what it means to be a doctor.”

severe acute malnutrition, among other tropical and common childhood diseases. His last field assignment to date was in 2007 in Kampong Cham, Cambodia, where he coordinated an emergency response to epidemic dengue. In between missions, Spitzer worked at St. Anthony Free Clinic in San Francisco’s Tenderloin neighborhood.

In 2006, Spitzer’s broad MSF experience led to his election to the MSF-USA board of directors; two years later, he was elected board president. In addition to chairing the board, Spitzer played a key role in developing new bylaws to strengthen the international association’s effectiveness, opening it up to new people and voices – especially from the countries in which MSF works. He also worked tirelessly as a political and medical advocate for the patients and populations MSF serves.

Just this summer, Spitzer stepped down as president, following the organization’s practice of regular renewal of leadership. Now based in New York City, he’s a faculty member at Columbia University’s Center for Family and Community Medicine, seeing patients and teaching students and residents at the Farrell Family Health Center and Allen Hospital in upper Manhattan. And he is thinking about what to do next.



TED WONG, DDS '84

*Commanding General, Southern Regional Medical Command;
Commanding General, Brooke Army Medical Center;
Deputy Director, San Antonio Military Health System;
26th Chief, US Army Dental Corps*

On Ted Wong's first tour with the Army in Stuttgart, Germany, his commander approached him and said, "There's a dental clinic nearby with an officer-in-charge position open; would you like it?" Wong remembers, "I thought he was actually asking me, so I told him I'd like to talk about it with my wife. After a pregnant pause, I realized he wasn't asking me – he was telling me. From that moment, I learned when I'm asked, 'Would you like to do this,' just to say, 'If I was king of the world, there's nothing I'd like more.'"

That can-do attitude has propelled Wong from running a single dental clinic to leading three Army tertiary care and academic medical centers, six community hospitals, two community health centers, 38 health clinics, the largest hospital in the Department of Defense – and more.

It's all part of his vast scope of responsibility as commanding general of both the US Army's Southern Regional Medical Command and Brooke Army Medical Center in San Antonio, Texas; deputy director of the San Antonio Military Health System; and chief of the US Army Dental Corps.

"My job is to make sure that everybody else can do their jobs,"

Wong says. "To make sure they have the resources, personnel, equipment, and policies to perform effectively and efficiently, so we can provide the best quality care to our men and women in uniform."

To meet this objective, Wong is overseeing innovation on every front. For example, one piece of equipment developed at Brooke Army Medical Center is quickly becoming indispensable: the Intrepid Dynamic Exoskeletal Orthosis (IDEO). It was designed at the facility's Center for the Intrepid, world-renowned for treating and rehabilitating

"It's been great to serve with dedicated professionals who provide care to the most deserving patients in the world."

soldiers with traumatic limb injuries and severe burns. An energy-storing orthopedic device made from carbon and fiberglass, the IDEO allows patients – who couldn't previously stand or walk due to lower leg injuries – to run again. This means a wounded soldier can return to his or her unit rather than face a medical discharge, Wong explains. And as deputy director of the San Antonio Military Health System, Wong is partnering with the local US Air Force medical services to develop a high-performing, integrated military health organization.

When not leading medical centers, Wong establishes professional standards and policies for the US Army Dental Corps. As chief, he also advises the surgeon general and the Army's chief of staff on all dentistry matters and the dental health of the Army.

After graduating from UCSF in 1984, Wong joined the Army and practiced general dentistry for several years. Later he specialized in prosthodontics through an Army residency program. Eventually he was encouraged to move into management and found himself in increasingly higher levels of leadership. He earned two master's degrees – one in health care administration from Baylor University and another in strategic studies from the US Army War College – while completing tours across the world. In all, he moved with his wife and three children 15 times in 28 years to places like Oklahoma, Germany, Arizona, Hawaii, Korea, California, Pennsylvania, Texas, and Washington, DC.

Now that he's reached what he considers the pinnacle of his Army career, Wong is preparing to retire from the service in 2014. "It's a credit to the UCSF School of Dentistry and my parents that I was provided with the moral foundation, education, knowledge, and skills that enabled me to be as successful as I've been in the Army," he reflects. "It's been great being able to serve in two professions – arms and dentistry. And to serve with dedicated and talented professionals who provide care to the most deserving patients in the world." ■



Gideon, Susie, Jonathan, and Emily Grace Yu

Father of two angels. President and co-owner of the San Francisco 49ers. Former CFO of Facebook and YouTube. That's how Gideon Yu describes himself in his profile on Twitter. And in his family's experience at UCSF, the first label especially comes to life.

Sometimes Gideon gazes upon his now 5-year-old son, Jonathan, asleep and snuggled up against mom Susie, and thinks: “This is what heaven must look like.” Then he remembers how that heaven was threatened.

Jonathan was just two months old when his parents rushed their crying baby to a local emergency room. Eleven grueling hours passed before X-rays, blood tests, and scans revealed a broken bone and something more worrisome: a potential issue found in a scan of Jonathan's brain. “We were first-time parents, and we were freaking out because after 11 hours, we still had no answers,” recalls Susie. When no one at the hospital could provide the assistance or information they so frantically sought, the Yus realized they were falling through the cracks, and mobilized every acquaintance in search of help for their son. The resounding recommendation: Get Jonathan to UCSF. Today, they say it was the best advice they've ever received.

At the UCSF children's hospital (now named UCSF Benioff Children's Hospital), Gideon watched solemnly as Jonathan lay restrained, a CAT scan beam casting a grid of red lights across the boy's tiny face. “In that moment, I just held Jonathan's hand and cried, wishing he didn't have to

go through this,” Gideon recalls. Over the next several days, the compassionate, informed attention of a UCSF specialist in pediatric neurology put them at ease, Gideon and Susie say. With a clear sense of their options, and the recommendation to monitor Jonathan closely as he approached each new developmental target, they brought their angel home. And they took action to ensure that other parents with threatened angels of their own can receive the exceptional care Jonathan experienced at UCSF.

Today, Jonathan is a normal, happy, and – most important – healthy little boy. Like his parents, he's fun-loving and compassionate. He's also very excited to be a big brother to little Emily Grace, who was born in July. Gideon and Susie are active angels of UCSF, through philanthropy and through the gifts of their time, energy, and considerable talents. “When I think about the next chapter of my life, I know I want to contribute to great causes like UCSF,” says Gideon. “With three Mission Bay hospitals in place, UCSF will be even stronger. We're proud to support that outcome in any way we can.” And he and Susie want Jonathan and his new little sister, as they grow, to experience all the opportunities under heaven.

Alumni Hub

INAUGURAL ALUMNI WEEKEND WOWS

UCSF hosted its first campus-wide alumni reunion on April 19-21, 2012. The event united all four professional schools – dentistry, medicine, nursing, and pharmacy – and the Graduate Division. The largest alumni event in UCSF history, the weekend drew more than 1,800 alumni, faculty, students, staff, and friends from 24 states and four countries. Attendees enjoyed more than 65 events held at the Palace Hotel and on both Parnassus and Mission Bay campuses – and some serious fun.

Save the date! Alumni Weekend 2013, April 25–27, Palace Hotel and UCSF



PHOTOS: NOAH BERGER; UCSF



AAUCSF President's Message

On behalf of the Alumni Association of UCSF (AAUCSF), the umbrella alumni organization for the University, I hope you enjoy this inaugural issue of *UCSF Magazine*. This publication represents one of many new initiatives UCSF has undertaken recently to better connect with its alumni. Here are some others:

- AAUCSF has clarified the scope of our membership to embrace all UCSF degreed alumni and trainees – including residents, fellows, and postdocs.
 - AAUCSF has revitalized our board of directors by implementing five committees focused on campus-wide initiatives: Advocacy, Alumni Weekend, Diversity and Outreach, Regional Engagement, and Student-Alumni Engagement.
 - UCSF hosted its inaugural comprehensive Alumni Weekend at the Palace Hotel with more than 1,800 participants. We hope that you'll join us next year on April 25–27.
 - UCSF is sending new school and program-based e-newsletters on a regular basis. (If you are not yet receiving them and you'd like to, please email your name, degree, year, and preferred email address to alumni@support.ucsf.edu.)
 - AAUCSF established active regional chapters in Boston, Hawaii, Los Angeles, New York, San Francisco, and Washington, DC.
 - UCSF launched a new online alumni community at www.ucsfalumni.org, a dynamic and interactive portal that features a calendar of alumni events, a membership directory, an area for groups to congregate, message boards, and more. (Please log on and sign up!)
 - AAUCSF started a new grants program that allows groups that support our mission to apply for grant funding.
 - Dozens of alumni and friends have participated in our UCSF travel programs to Europe, Asia, and Latin America.
- Our work is not done. We are planning many new and exciting initiatives in the coming year. We hope you'll join your classmates at Alumni Weekend 2013 or at one of our various activities.
- Please contact Andrew Kaufteil at 415/476-6345 or akaufteil@support.ucsf.edu if you are interested in getting involved as a volunteer, or if we can be of service in any way.

John Skhal, PharmD '71

President, Alumni Association of UCSF



School of Dentistry

MILGROM: DAA MEDAL OF HONOR WINNER

DAA President's Message

The Dental Alumni Association (DAA) is a vibrant organization of dentists and dental hygienists who support the School of Dentistry through student outreach and a host of alumni activities. We are also committed to supporting alumni by facilitating ways for you to remain in touch with the school and with each other. New this year is our online community, www.ucsfalumni.org, where you can access the alumni directory, class notes, membership and benefits, and events.

Furthermore, our annual UCSF DAA Scientific Session is an outstanding two-day event filled with CE courses, class reunions, and networking events for all dentistry insiders. Save the date for the 117th Scientific Session at Alumni Weekend, April 25–27, 2013.

We are always looking for alumni interested in getting involved with our UCSF family. To attend DAA Executive Council meetings, join a committee, or share your expertise, please contact daa@support.ucsf.edu.

We look forward to your participation and support to keep our dental alumni association strong!

*Douglas Cowden, DDS '65
President, Dental Alumni Association*

One big troublemaker.

That's how Peter Milgrom, DDS '72, describes himself. Always questioning the status quo, asking why, shaking up the system. Yet that very tendency has led to a remarkable career noted for bringing disparate groups together to serve the public.

"It's just in my blood," he says. "I believe in this work."

After his outspoken student leader days at UCSF, Milgrom gained a "shoe leather" education at the fledgling Institute of Medicine. "I didn't have a clue about anything back then," he laughs, "but I was exposed to famous leaders in health care. It was an exciting place to be."

From there he followed a mentor to the University of Washington to join the Community Dentistry Department. Milgrom soon became chair and built a large multidisciplinary research program populated with everyone from biostatisticians to clinical psychologists.

The psychologists would help

chart much of Milgrom's career.

"They were interested in phobic adults and kids who wouldn't go to the dentist," he explains. From that inquiry the Dental Fears Research Clinic was born. Milgrom became its director and an expert in the



field, conducting groundbreaking pharmaceutical studies, writing a classic textbook, and treating thousands.

This work stirred another passion in the early 1990s: preventive care for low-income kids. "Nobody

took care of 1- and 2-year-olds back then," he says. So he started the Baby and Child Dentistry Program, bringing together people from the university, public health department, state dental association, and Medicaid to train dentists and improve access. Since the program's inception, the number of young children on Medicaid in Washington who receive dental care has more than tripled.

It's just one of the many collaborations Milgrom, now a professor of dental public health sciences, has initiated over the years to bring better dental care to the underserved. "I love these partnerships," he says. "They empower the field to do something new."

"These accomplishments illustrate Dr. Milgrom's creativity, leadership, and commitment to service that characterize his career," wrote faculty peer Peter Domoto, DDS '64, MPH, in his Medal of Honor nomination letter. Not bad for a troublemaker.

INAUGURAL ALUMNI WEEKEND 2012



Left: School of Dentistry Dean John D.B. Featherstone, UCSF Chancellor Susan Desmond-Hellmann, Herb Gabriel, DDS '43, and School of Nursing Dean David Vlahov enjoying Alumni Weekend's Breakfast with the Chancellor.

Right: DAA Secretary Carmen Hipona, DDS '96; DAA President Mary Porteous, DH '75, MSDH '12, and DAA Vice President and Scientific Session Chair Roy Nesari, DDS '06, celebrate another successful UCSF DAA Scientific Session.

CAMAISA: DAA MEDAL OF HONOR WINNER

Dedication Defined



Ask any dentist about his or her biggest challenge and the list might include prickly patients, tough procedures, or billing headaches. Ask Ted Camaisa, DDS '89, and he might say dodging missiles.

Running for shelter was just one of the obstacles the Navy Dental Corps officer faced serving with the marines during the Iraq War. There was also the heat – 120 degrees inside the tent clinics – the pent-up demand for care by the coalition forces, and the difficulty of treating soldiers with facial trauma. “You just really had to block everything out and focus,” he says.

For his exemplary leadership during this tour, Camaisa was awarded a Meritorious Service Medal by the president – one of a long list of awards and decorations he has earned.

Camaisa also served during the Gulf War on a ship near Dubai. After the war concluded, the vessel headed to Subic Bay in the Philippines to refuel. Just as they sailed into port, Mount Pinatubo erupted. “The sky was completely black and the port filled with ash,” he says. The Naval crew helped the citizens dig out from the disaster and provided clean water.

Camaisa has made quieter, but still significant, contributions during his time with the Navy. He has

run clinics small and large – one served 10,000 marines – and cared for many patients who were seeing a dentist for the first time in their lives.

He also led a humanitarian mission on Tinian Island in the Marianas and spearheaded a mentorship program with an elementary school in San Diego. “He carries community spirit and service around the world, even in the remotest area of the Pacific,” wrote James MacDowell, DDS '01, in his Medal of Honor nomination letter, concluding: “Captain Camaisa is a credit to UCSF, the dental profession, and the nation.”

Applications are now being accepted for the 2013 Medal of Honor. To nominate fellow alumni, please contact daa@support.ucsf.edu.



MS in Dental Hygiene Program Completes First Year

UCSF School of Dentistry faculty, students, alumni, and friends celebrated as the inaugural class in the school's Master of Science in Dental Hygiene (MSDH) graduated in June. “This program is an important milestone, not only because it will help address the need for academic leaders and educators in dental hygiene, but also because it's the culmination of more than 30 years of effort by alumni and UCSF dental hygiene faculty – in particular, doctors Jean Poupard, Helen Ishida, Norma Francisco, and Dorothy Rowe, as well as professors Judy Yamamoto and Barbara Heckman,” says the program's director, Margaret Walsh, DH '69, MS, EdD.

MSDH Class of 2012 and friends (left to right, back row): Bill Bird, Margaret Walsh, DH '69, Elena Ortega, DH '88, Michaela Nguyen, Uyen Nguyen, DH '04, Ruth Kearn, DH '91, Serai Graham, DH '04, Dean John D.B. Featherstone, Joyce Sumi, Elizabeth Couch, Nicolette Moultrie, Diane Dodd, Ellen Darius, DH '05, Barbara Heckman; **(front row)** Mary Porteous, DH '75, Kirsten Jarvi, DH '95

GET INVOLVED!

Join the Dental Alumni Association Executive Council

The DAA is looking for new Executive Council officers and committee members to join the current elite and dedicated group of alumni leading the DAA. As an officer or committee member, you will represent alumni, organize events, and provide general direction for the DAA. To learn more, please contact 415/476-3322 or daa@support.ucsf.edu.

Or participate by:

- Serving as a mentor for current students
- Joining the UCSF School of Dentistry volunteer faculty program
- Attending alumni mixers, receptions, events, and gatherings
- Participating in alumni panels

CLASS NOTES

Betty Chapman, BS, DH '62, is retired and lives in Sacramento with her husband, Michael, a 1962 graduate of the UCSF School of Medicine. Presently Betty is serving a two-year term as chair of the UC Davis Leadership Council and is a member of the UC Davis Foundation.

Donald Q. Streutker, DDS '62, enjoys traveling and most recently toured South Africa and Scandinavia with his classmate Sam Weeks. Don continues to care for his patients, many of whom span three and four generations of families.

Read more class notes online at www.ucsfalumni.org.

SAVE THE DATE

117th UCSF DAA Scientific Session at Alumni Weekend

Palace Hotel
San Francisco
Friday and Saturday,
April 26–27, 2013



Hibret Hailu Benjamin, DDS '02, connects with fellow UCSF alumna at the 116th UCSF DAA Scientific Session.



MAA President's Message

I would like to personally welcome you to the first issue of the new *UCSF Magazine*. I am very excited about this new chapter in UCSF publications for our alumni. For many years, the Medical Alumni Association (MAA) has provided you with the *Medical Alumni Magazine*. We have always been very proud of our magazine, with its timely stories and insightful reporting about School of Medicine alumni, students, and faculty. This new magazine will not only continue to deliver great stories and reporting, but will also offer you a look at UCSF the way the current student body sees it: with an interprofessional view.

Those of you who attended this past year's amazing Alumni Weekend got to experience the interprofessional view first-hand. We attended events side by side with alumni from all of the UCSF professional schools. One medicine alum said, "I was skeptical about mixing all the schools together, but now that I am here, I feel like I am part of something much larger." It is my hope that you also will be able to feel like you are part of something much larger, by way of this magazine.

Donna Hoghooghi, MD '98
President, Medical Alumni Association

School of Medicine

SUTHERLAND: LEGACY AWARD WINNER

Excellent Educator Receives Recognition

Sexton Sutherland, PhD, never planned on becoming a teacher. But in 1972, he got a call from Jack DeGroot, MD, interim chair of the UCSF Department of Anatomy. DeGroot needed someone to teach the summer anatomy course, pronto.

Now, 40 years later, Sutherland has earned the Haile T. Debas Academy of Medical Educators Legacy Award – bestowed upon him by the Class of 1982 at the Medical Alumni Association Awards Luncheon, during the first-ever UCSF All Alumni Weekend in April 2012. Given annually by an alumni class in reunion, the award is reserved for inspirational School of Medicine educators.

"Anatomy is a class you take right at the beginning of medical school, and it's one of the most memorable," says Carolyn Klebanoff, MD '82, who presented Sutherland with the award. "Sexton had this way of

taking a situation that was innately awkward – brand new medical students with this human body in front of us – and making it an amazing learning experience. He made it fun and accessible."

Although Sutherland hadn't had much experience teaching when he started, he quickly secured a place in students' hearts. "Students are intelligent and motivated; you can just talk to them and be real," he says. "If you don't know something, you say, 'I don't know; I'll look it up.' They respect you for that."

When he heard he had been selected to receive the Legacy Award, Sutherland was incredibly humbled. He notes, "I don't think of myself as an award-winning teacher. I think of my life and teaching as being a ball. It was just a great, great time."



Sexton Sutherland accepts the Legacy Award from Class of 1982 representative Carolyn Klebanoff.

CHAPMAN: MAA ALUMNUS OF THE YEAR

After All the Kings Horses

Alumnus of the Year Mike Chapman, MD '62, snowplowed his way into orthopedics. A ski racer at heart, Chapman only used the snowplow when towing an injured skier in a litter to safety. His ski patrol duties not only paid the bill for his ski habit, but also gave him his first glimpse of the discipline that would define his life.

Chapman is one of the founders of traumatology, a subspecialty of surgery that treats the severely injured. As Chapman tells it, the specialty grew out of breakthroughs made during the Vietnam War: larger, faster helicopters and better emergency care as well as

sophisticated resuscitation techniques increased the rates of early survival of wounded soldiers. This translated quickly into civilian life. "All of a sudden we had a whole bunch of patients who were surviving severe car and other accidents," says Chapman. So began traumatology and Chapman's career.

After his service in the Army in Europe during the Vietnam War, Chapman brought his expertise to UCSF as assistant chief of orthopedics at San Francisco General Hospital from 1970 to 1979. When he wasn't at the hospital, he was traveling with the US Ski Team as one of its physicians. He also developed the ski boot testing

program for *Skiing Magazine*.

Chapman had to give up his ski team duties when he was asked to chair orthopedics at UC Davis in 1979, a position he held until he retired in 2000. He and his colleagues transformed UC Davis' hospital into a level 1 trauma center, reducing its rate of preventable deaths due to trauma to less than 1 percent.

"Having spent my career in university hospitals working with the indigent, I have come to appreciate the general vulnerability of the human race," says Chapman. "We really have to figure out how to deal with that vulnerability, manage it, and treat everyone."

RUBIN: MAA ALUMNUS OF THE YEAR

The Reluctant Spectacle

Melvin L. Rubin, first in his class at UCSF in 1957 and Alumnus of the Year in 2012, earned every second of his extraordinary career with intellect and kindness, except one. He got lucky when the Army had no need for a newly trained ophthalmologist, giving him the opportunity to complete his service at the National Institutes of Health. It would prove a life-defining job that would launch his exceptional trajectory.

As executive secretary of the training grants committee, Rubin, MD '57, staffed people in academic ophthalmology programs all over the country. "Even though I was still wet behind the ears, I was on a first-name basis on a committee with the most prominent ophthalmologists from the best schools in the nation," he says.

In 1963, Rubin joined the University of Florida's new medical school as the ophthalmology chair's second hire. He went on to chair the department himself for 20 years. "I grew up with the department over 50 years and still go to grand rounds every week," he says. "I know every resident and fellow ever trained here."

Rubin's career has had an enormous impact on his profession. He developed a test called the Ophthalmic Knowledge Assessment Program to gauge his residents' knowledge of their specialty. So definitive and effective was the test that it became the standard for every eye residency training program in the United States and Canada – and still is.

Rubin is also a prominent writer in the field, having authored over 100 scientific publications and seven textbooks. He and co-author Benjamin Milder, MD, received an "Ammy" – the best medical book of the year from the American Medical Writers Association – for *The Fine Art of Prescribing Glasses without Making a Spectacle of Yourself*. He credits his son, who went on to write the screenplay for "Groundhog Day," for the title.

"The mind should boggle when we think of all of Mel's accomplishments in his field, but I for one am not surprised," according to classmate Richard Russell, MD '57. "Mel was destined for greatness, a being sent to us from a different realm – a better one, I guess."



Double honor: Melvin Rubin (left) and Mike Chapman share the MAA's highest honor, Alumnus of the Year.

**Serious Fun
at Inaugural Alumni Weekend 2012**



Clockwise from top left: Tour-takers in the Ray and Dagmar Dolby Regeneration Medicine Building; Chancellor Susan Desmond-Hellmann, Mignette Najarian, John Najarian, MD '52; Mark Goodarzi, MD '97, John Duffy, MD '97; Members of the class of 1982; Ronald Krug, MD '62, James Gibbons, MD '62, Jack Maidman, MD '62, and Mike Chapman, MD '62; Stella Dao, MD '92.



NAA President's Message

All graduates of the UCSF School of Nursing are conferred membership in the Nursing Alumni Association (NAA), a network of more than 9,000 worldwide alumni that provides mutual support and friendship. Through the board of directors and its committees, the NAA develops events and programs to foster an engaged community and support the school in preparing the world's finest advanced-practice nurses and researchers.

You can enrich the NAA with your active participation. Attend an event, precept a student, mentor a recent grad: there are many ways that you can contribute to our vibrant alumni community!

*Catherine Camenga, MS '03
President, Nursing Alumni
Association*

School of Nursing

BUFFUM: NAA ALUMNUS OF THE YEAR

And the Crown Goes to...

It was the fall of 1966 and freshmen were swarming Parnassus. Kappa Psi, the pharmacy fraternity, was eager for new members. As an enticement, the brothers persuaded some new nursing students to attend a party. That's when Marti Buffum (née Davis), BS '69, MS '70, DNS '92, met John, PharmD '70 – and so began the Buffum dynasty. They would marry during her senior year and go on to have two sons, both of whom went to UCSF: Mike, PharmD '98, and David, Nursing '10. David followed the Buffum biological imperative of falling in love with and marrying a fellow UCSF student, Lisa (née Hardenbrook), Nursing '10.

Marti Buffum confirms that there is now a third generation in play, a granddaughter, Laurel, age 6. She was recently caught singing on her school bus. The driver asked, "Are you going to be a rock star one day?" To which she replied, "No, I'm going to be a pharmacist." Let's just hope she meant a UCSF pharmacist, or she may have some pretty lonely family holidays ahead.

Alumnus of the Year Marti Buffum's commitment to UCSF runs deeper still. After having her two boys, staff nursing for 20 years, teaching psychiatric nursing for 13 years, opening a private practice as a psychiatric mental health clinical nurse specialist, and completing her doctorate, Buffum found her dream job. She became the associate chief of nursing for research at the San Francisco Veterans' Affairs Medical Center, a UCSF affiliate.

"This job combined everything I had been doing into one position filled with opportunities! I got to work with veterans as a clinical

nurse specialist, co-lead groups with veterans with dementia, conduct research, develop a program of nursing research, mentor nurses, conduct and teach journal clubs and evidence-based practice, and consult on the hospital units for varying nursing crises," says Buffum. "The position was perfect." So much so that she stayed in the job for almost 19 years.

Buffum's own research has long focused on pain in patients with dementia. "I have worked to improve pain assessment and treatment in patients who are unable to report it," she says. Collaborating with University of San Francisco colleagues, she has also investigated behavioral management of auditory hallucinations in persons with schizophrenia. She has been teaching these techniques to psychiatric staff in the hospital and community.

Though retired, Buffum continues her clinical involvement and teaching. She is currently consulting with colleagues to develop staff sensitivity to the burden of auditory hallucinations and teach symptom management skills. "We have devised tools to help nurses

talk to their patients about the voices they hear," says Buffum. "It creates a bond between patients and practitioners. Patients tend to feel connected to nurses who have truly listened to them during an interview process about their experiences with voices."

She carries with her two distinct memories of UCSF, besides meeting her husband. First is the fear of statistics that she left behind. "My statistics professor, Dr. Steve Paul, taught so well that he completely changed my thinking," says Buffum. "I thought I could never do quantitative research." Yet she spent most of her career doing quantitative studies. The second memory is of the words of one of her faculty collaborators, Chris Miaskowski, PhD. "She told me that whenever we do research with our patients, we owe it to them to publish the findings," says Buffum. Those words drove her toward a very fruitful research career – one that the next generation of the Buffum dynasty will no doubt carry on. And the next. And the next.



The Buffum dynasty (from left): Son Michael, Marti, husband John, son David, and his wife, Lisa.



Dental Alumnus Establishes Scholarship in Memory of Nursing Alumna Wife

Herbert and Betty Gabriel met as students at UCSF, married, and enjoyed 60 years of marriage before Betty passed away in 2004. This year Herb, DDS '43, found the ideal way to memorialize Betty, BS '43 – a gift of \$250,000 to the UCSF School of Nursing for student scholarships. It matched the extraordinary gift UCSF Chancellor Susan Desmond-Hellmann, MD, MPH, and her husband, Nicholas Hellmann, MD, recently made to the campus: \$1 million for professional student scholarships, divided equally among the schools of dentistry, medicine, nursing, and pharmacy.

SAVE THE DATE

Alumni Weekend 2013!

Make plans now to attend the second annual UCSF Alumni Weekend on April 25–27, 2013. Nursing-specific events will be held over the last two days at the Palace Hotel and UCSF campuses in San Francisco. Discounted hotel rooms are offered at the Palace Hotel. Learn more at www.ucsfalumni.org.

STUDENT SPOTLIGHT

Through the generosity of alumni, the NAA helps the school attract the best students, regardless of financial background, through its endowed scholarship fund. Congratulations to Rachel Larson, MS '13, Daniel Linnen, MS '13, Leah Sanchez, MEPN, MS '14 (pictured below) and Stephanie Phelps, PhD '13, who were selected to receive \$4,000 scholarships.



PHOTOS, THIS SPREAD: NOAH BERGER; UCSF

GET INVOLVED!

Join Our Online Community – www.ucsfalumni.org

Visit our online community to access the alumni directory, job exclusives on LinkedIn, friendships on Facebook, photos on Flickr – and more.

Stay Connected

Keep in touch with the school's latest research and honors through the monthly online *Alumni eNews* and *Science of Caring* publications. If you are not receiving them and would like to, please send your preferred email address to mismith@support.ucsf.edu.

Volunteer as a Preceptor

The need for preceptors in the greater Bay Area is strong and year-round. Please share your expertise with the next generation

of advanced-practice nurses. To participate, email your name, preferred email address, name of employer, position, specialty, and graduation year to Linda Sawyer, UCSF Nursing Academic Services Coordinator, at linda.sawyer@nursing.ucsf.edu.

Serve as a Mentor

Through the Career Alumni Network, the NAA strives to connect current students and NAA members at any stage of their careers with mentors able to provide career coaching. Mentors participate in informational interviews, provide job shadowing experiences, and speak on career panels. Learn more from Kathleen Cassidy, UCSF Office of Career and Professional Development, at 415/476-5772 or kathleen.cassidy@ucsf.edu.

Attend an Event

Events for alumni with students, faculty, and special guests are held throughout the year. Learn more and RSVP for events at www.ucsfalumni.org. You are also invited to stop by UCSF School of Nursing socials at the annual meetings of the American Academy of Nursing and Western Institute of Nursing.

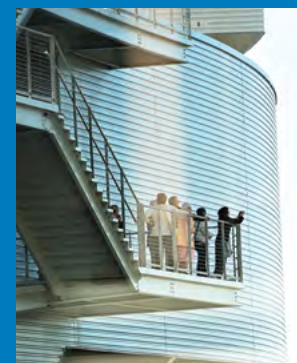

Alumni enjoying a tour of the Ray and Dagmar Dolby Regeneration Medicine Building during Alumni Weekend 2012.

School of Pharmacy

KOMOTO: PAA DISTINGUISHED ALUMNUS OF THE YEAR

Extraordinary Entrepreneur

At the Komoto Pharmacy in Delano, Calif., customers form a line from the counter almost all the way to the front door – even though the chain pharmacy a few blocks away seems as if it inhabits a ghost town.

One explanation could be that the proprietor, Brian Komoto, PharmD '81, has infused his staff with a simple motto: "People do not come to our pharmacy to shop. They come because they have a problem. It's up to us to help them leave with a solution. Let's exceed their expectations; if we do, they'll never leave us."

That motto has propelled Komoto from a corner pharmacy that filled just 100 prescriptions per day to a pharmacy enterprise of six businesses.

Komoto grew up in Fresno, the

grandson of a Japanese-American department store owner who kept paying rent even when he was relocated to an internment camp during World War II. Raised in the family business, Komoto learned how to be a successful businessman by serving his customers' needs. Years later, upon graduating from UCSF, he bought the pharmacy in Delano from a Japanese-American owner who wanted to sell only to the descendant of a family who also had struggled through the camps.

Though Komoto wondered how he could practice clinical pharmacy from a corner drugstore, he got a chance in the first week of business, when he received a prescription for two conflicting gastrointestinal drugs that caused him to request an adjustment. The prescribing physician gruffly called him a "young

whippersnapper," but agreed to adjust the prescription. Later that evening, the physician actually stopped by to thank Komoto, saying, "We need kids like you!"

While his accomplishments prove he is the consummate entrepreneur, Komoto has never strayed from his motto. In a letter nominating him for Distinguished Alumnus of the Year, Carol Sorrell, CEO of Kern Health Systems, on whose board Komoto sits, wrote, "Brian supports policy based upon what is best for the delivery of medical care and the recipients of medical care, not what is best for his business interests."

Of being named Distinguished Alumnus, Komoto says: "I don't deserve it. The previous winners are truly the leaders of the pharmacy community. I still have much to do to deserve to be on that list."

PAA President's Message

Last year I asked the question, "Where would I be without UC?" I still stand by everything I wrote in the fall 2011 *Pharmacy Alumni Association Newsletter*, and I encourage you to read it in our publications archive at www.ucsfalumni.org. I also encourage you to think about where YOU would be without UC, and to think about giving back to the place where it all started.

The Pharmacy Alumni Association (PAA) has many events planned in the year ahead to connect you with the school, its students, and each other. I hope you have enjoyed the monthly eNews we initiated this year. We are also continuing to build our online presence with a new online community, www.ucsfalumni.org, where you can find friends and classmates, and keep abreast of everything going on at UCSF.

The PAA is ably governed by a board consisting of graduates from every decade. Three new members joined us this year: Brian Komoto, PharmD '81, Marilyn Stebbins, PharmD '88, and Mimoso Tran, PharmD '04. I'd like to thank Gary Laird, PharmD '91, Donna Dare, PharmD '84, and Nathan Singer, PharmD '10 for their many contributions as they complete their terms on the board of governors.

It has been a privilege to serve as president, and I look forward to connecting with many of you over the coming year. I hope you will let me know how the PAA can better serve you!

*Wilma K. Wong, PharmD '73
President, Pharmacy Alumni
Association*



Brian Komoto receiving his award from PAA President Wilma Wong; consulting with a patient at his flagship store, Komoto Pharmacy, in Delano, Calif.

CLASS NOTES

Dianne Tobias, PharmD '71,

recently encountered an acquaintance who is in his first year at UC Davis medical school. She writes, "The fact that I am a UCSF pharmacy school alumna came up as we were talking about his studies. What was interesting was how utterly impressed he was with UCSF. Several of his contemporaries had applied to pharmacy schools, which is why he knew that UCSF has long been the No. 1 school of pharmacy and how difficult it is to be admitted. He asked if I knew that it was harder to get into UCSF pharmacy school than UC Davis medical school! I just smiled and let the pride of being a UCSF alumni wash over me."



Nathan Singer, PharmD '10,

completed a specialty PGY1 residency in Informatics and Technology at UCSF, followed by a PGY2 in Health Systems Pharmacy Administration with Kaiser Permanente in Downey, Calif., where he is now a supervisor of the 24-hour outpatient hospital discharge pharmacy.

Read more class notes online at www.ucsfalumni.org.

Brian Komoto's Pharmacy Enterprise

- Komoto Pharmacy locations in Delano and Bakersfield operate by automated robot for simple prescriptions, eliminating errors and freeing pharmacists to focus on more challenging prescriptions. The pharmacies also manage diabetic patients for self-insured employers.
- Komoto Healthcare serves patients from San Joaquin to Kern counties.
- Optimal Pharmacies specializes in compounding drugs – even veterinary pharmaceuticals – and serves 19 states. It also developed the drug formulary for the California Department of Corrections.
- Integrated Care Systems focuses on IV therapy and specialty pharmacy. It created a hepatitis C program to improve therapy compliance and outcomes.
- Synergy Pharmacy Solutions assists hospice providers and prevents hospital readmissions.
- Synergy Healthcare Services provides specialized nursing.

SAVE THE DATE

Alumni Weekend 2013!

We had a tremendously successful UCSF Alumni Weekend this past spring, so make plans now to attend the second annual UCSF Alumni Weekend on April 25–27, 2013. Pharmacy-specific events will be held over the last two days at the Palace Hotel and UCSF campuses in San Francisco. Discounted hotel rooms are offered at the Palace Hotel. Learn more at www.ucsfalumni.org.

GET INVOLVED!

Join Our Online Community – www.ucsfalumni.org

Visit our one-stop shop for alumni news, event information and registration, message boards, and a directory for connecting with classmates. Please send us story ideas or personal news to publish in the class notes section.

Volunteer for a Reunion Committee

Let us help you celebrate your milestone graduation anniversaries by planning a class reunion. Each year at UCSF Alumni Weekend, classes in milestone anniversary years (5th, 10th, 15th, etc.) gather to reconnect. It takes dedicated volunteers with a variety of skills to make a reunion a success!

Host an Alumni Event in Your Region

Each year the PAA hits the road and hosts a number of events for alumni across the state and beyond. These are typically casual gatherings that draw a few dozen alumni and students from the local area. Please let us know if you have an idea for an event in your area, and we can help you pull it together.

Support Our Students

Our students are the future of our profession, and the PAA has a number of programs to help connect students to alumni to enrich their UCSF experience. Alumni benefit greatly from interacting with students and vice versa. From attending fun social events to participating in mentorship programs, mock interviews for internships and residencies, and professional networking opportunities for career development support, you can make a difference in our students' professional futures.

To learn more about these opportunities, please contact udarpaa@support.ucsf.edu.



Graduate Division

PhD and Postdoctoral Alumni

A NEW DEAN FOR THE GRADUATE DIVISION

Elizabeth Watkins, PhD, Brings a Dynamic Past to the Future of Graduate Studies

GDAA President's Message

It is with great pride and excitement that I welcome you to the Graduate Division Alumni Association! The GDAA serves alumni of UCSF graduate and postdoctoral programs, and offers you an easy way to reconnect with friends, labmates, and classmates, make contact with colleagues around the country, and meet today's students, postdocs, and faculty.

Our mission is to support a strong community among the researchers trained at UCSF. As part of that commitment, the Graduate Division now offers a host of alumni programs including regional receptions at professional meetings, a quarterly e-newsletter, and a new online community at www.ucsfalumni.org. We also enjoyed the inaugural Graduate Division reunion at this year's UCSF Alumni Weekend, which was a tremendous success. Be sure to save the date for next year's UCSF Alumni Weekend, April 25–27, 2013!

It is a privilege to serve as president of the GDAA, and I look forward to connecting with many of you over the coming year. I hope you will let me know how the GDAA can better serve you!

Alexandra Schnoes, PhD '08, Biophysics President, Graduate Division Alumni Association

As dean of UCSF's Graduate Division, you oversee hundreds of scientists. Did you ever want to be one yourself?

Dean Watkins: My undergraduate major at Harvard was biology, and I thought that I was going to be a scientist. I took a year off between my junior and senior years and got a job at the Pasteur Institute in Paris as a research assistant. I found that the actual day-to-day work of running gels and dissecting mice muscles wasn't for me. I was really interested in the larger questions that were being asked: What did this research mean?

You have a doctorate in the history of science. What led you down that path?

Dean Watkins: Teaching. After I graduated, I taught biology and chemistry first at a Catholic high school, then four years at a boarding school. My third year I developed an elective called Science in Modern Society and fell in love with the subject. It was my "a-ha!" moment – I knew it was really what I wanted to study in depth.

How does your former job as director of graduate studies for the UCSF History of Health Sciences program inform your new position?

Dean Watkins: First, my research career has involved studying how scientists and physicians communicate with their publics. I have spent a lot of time thinking about information flows between expert and lay communities. That's been useful to me in this job because so much of the great work that's being done by PhD students in the basic sciences needs to be translated for a non-scientist audience.

Second, I learned from the diversity of the students who have come to UCSF to study the history of health sciences the importance of making sure the admissions to

all of our graduate programs are as inclusive as possible.

Is there a quality of the UCSF graduate student that is different from those in other institutions that you've encountered along the way?

Dean Watkins: I'm really proud to be part of a state institution, and I think many of our graduate students are, too. UCSF transforms and shapes the economy and the culture in San Francisco, the Bay Area, and the state. People who come to this university appreciate that we serve the community. It's more obvious for those students who choose to go into clinical careers. But I actually think it's quite clear for our academic research students as well, because they believe that the work they're doing now has the potential to be part of a major innovative drug or discovery down the road. And the impact of such an achievement can have enormous social benefit.

What do you want to accomplish in year one?

Dean Watkins: To raise the profile of graduate education both on and off campus. Some call our 1,000 PhD students and 600 master's students the lifeblood of the institution; others call them the engines that drive research. Whatever the metaphor, they are really the ones who think about research problems in new ways. They bring faculty together who might not normally have found each other. It's a pleasure to highlight the innovative work being done by UCSF students.

In my unofficial, anecdotal poll of people in the Bay Area, I have found that many people think of UCSF as a hospital; if you press them a little more, they remember that there's a medical school. I see it as my job to let them know that UCSF is a premier institution for biomedical



research and graduate education in the health sciences.

What is your biggest challenge?

Dean Watkins: Matching the financial packages that the private schools like Stanford, Harvard, and Johns Hopkins will offer our applicants.

You've written four books: *On the Pill: A Social History of Oral Contraceptives, 1950-1970*; *The Estrogen Elixir: A History of Hormone Replacement Therapy in America*; *Medicating Modern America: Prescription Drugs in History*; and *Prescribed: Writing, Filling, Using, and Abusing the Prescription in Modern America*. What's next?

Dean Watkins: As you can tell from the titles, I study the interplay of medicine, commerce, and culture. I have the third in a series of three articles coming out later this year on the pharmaceuticalization of testosterone and its use in male aging.

I hear you have a daughter at UCSF?

Dean Watkins: Yes, she is a third-year medical student. Since she is at the VA hospital and I am at Mission Bay, our workday orbits don't intersect much these days!

SAVE THESE DATES

UCSF RECEPTIONS AT NATIONAL MEETINGS 2012–2013

Society for Neuroscience

October 13–17

New Orleans

American Association of Pharmaceutical Scientists

October 14–18

Chicago, McCormick Place

American Anthropological Association

November 14–18

San Francisco, Hilton Towers

American Society for Cell Biology

December 15–19

San Francisco, Moscone Center

JP Morgan Healthcare Conference

January 7–9

San Francisco

American Society for Clinical Pharmacology and Therapeutics

March 6–9

Indianapolis

American Association for Cancer Research

April 6–9

Washington, DC

BIO International Convention

April 22–25

Chicago

UCSF CAMPUS ACTIVITIES

Alumni Weekend

April 25–27, 2013

UCSF campuses and Palace Hotel

Commencement

May 17, 2013

William J. Rutter Center, Mission Bay

GSA and PSA Alumni Dinners

Spring 2013

GS–ICEbreaker

Fall 2013

JOIN OUR ONLINE COMMUNITY

www.ucsfalumni.org/graduatedivision

The UCSF online alumni community is a great resource for networking with fellow alumni and for connecting with UCSF. It features an online directory of alumni from across all schools and programs, as well as the latest alumni resources, news, and events.

Visit www.ucsfalumni.org/graduatedivision to see what's new for PhD and postdoc alumni!



Inaugural Reunion Honors Favorite Faculty

More than 160 alumni, friends, faculty, students, and staff enjoyed the Graduate Division's first-ever reunion during UCSF's inaugural Alumni Weekend in April. The weekend event united UCSF's four professional schools and the Graduate Division, and more than 1,800 attended overall. A highlight for many from our graduate programs was the gala dinner, where former labmates gathered to honor their favorite mentors. Each group sat with its honoree to celebrate, reminisce, and offer gratitude.

Honoree or Group

David Stimson, PhD
Louis Reichardt, PhD
Alexander Johnson, PhD
Irwin "Tack" Kuntz, PhD
Julie Ransom
Patricia Babbitt, PhD
Genentech
UCSF Chapter of Society for Advancing
Chicanos and Native Americans in Science
Dean's Table

Alumni Table Chair

Dan Keller, MS '83
Dan Madison, PhD '84
Rebecca Smith, PhD '99
Robert Cerpa, PhD '89
Kinkead Reiling, PhD '89
Alexandra Schnoes, PhD '08
Mark Dresser, PhD '00
Student and Alumni Table

Professor Irwin "Tack" Kuntz celebrates with (clockwise from right) David Sullivan, PhD '01, Carolina Reyes, PhD '00, Jed Pitera, PhD '99, and his wife Jill Ross-Kuntz.



Sanki oi hashika taiji/Three mighty men conquering measles

Ochiai, Yoshiiku, 1833–1904

1870s

Striking artwork of deities slaying smallpox, cholera, and measles – not exactly what one might expect to find in a health sciences library. Yet the UCSF Library is home to more than 400 Japanese woodblock prints – such as the mighty men above – that offer a unique window into traditional Japanese attitudes toward health and illness. The majority of the prints date to the mid-to late 19th century, when Japan was opening to the West after almost 250 years of self-imposed isolation. For this visual feast we can thank, among many, former UCSF Chancellor John B. de C. Saunders, MD, who started the East Asian Collection in 1963 when he was UCSF provost and university librarian, as well as former librarian and curator Atsumi Minami.



Inspiring Leaders

UCSF has a long legacy of inspiring new leaders in the health sciences. Our four schools – dentistry, medicine, nursing, pharmacy – and graduate programs consistently rank among the very top in the nation, attracting and developing the finest minds.

To ensure that we continue our tradition of educating the best and brightest, we must maintain our commitment to access and affordability, regardless of financial circumstances. It's vital that our students avoid large debt burdens so that when they graduate they have every opportunity in the world – whether working in a community hospital, a research lab, or an African village.

We need private support to help us achieve our critical public mission. With that in mind, last spring we launched the four-year, \$100 million UCSF Education Fundraising Initiative, focused on new scholarships, fellowships, and innovations in teaching.

Our students have remarkable abilities and aspirations. With your generosity, their potential is limitless.

For more information on how to support education at UCSF, please contact Mark Boone, assistant vice chancellor, at 415/476-5828 or mboone@support.ucsf.edu.

support.ucsf.edu